

Layher® 

More Possibilities. The Scaffolding System.

LAYHER ALLROUND SCAFFOLDING® INSTRUCTIONS FOR ASSEMBLY AND USE

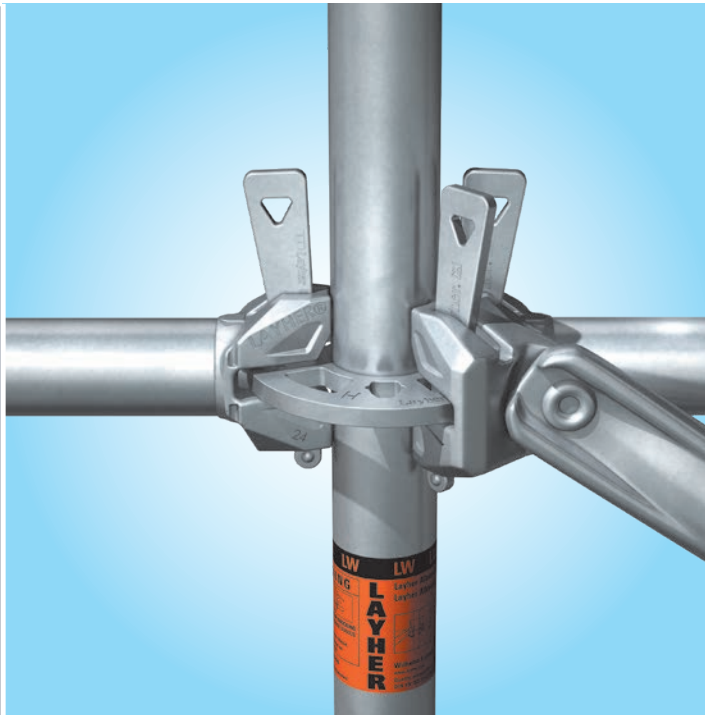

Edition 04.2018

Ref. No. 8116.230

Quality management
certified as per
DIN EN ISO 9001:2008



CONTENTS

1.	Introduction	4	17.	Bridging with lattice beams	47
2.	Measures for fall protection.....	7	18.	Brick guard.....	48
3.	General.....	11	19.	Ground adjustment.....	49
4.	Basic components of Layher Allround Scaffolding	15	20.	Change in standard configuration	49
5.	Facade scaffolding.....	22	21.	Use of the scaffolding	50
6.	Tower scaffolding	24	22.	Dismantling the scaffolding	50
7.	Birdcage scaffolding.....	27	23.	Components.....	52
8.	Shoring.....	28			
9.	Circular scaffolding.....	29			
10.	Suspended scaffolding	31			
11.	Mobile scaffolding units.....	33			
12.	Anchoring.....	34			
13.	Accesses	37			
14.	Deck cutouts and deck inserts.....	42			
15.	Corner solutions.....	43			
16.	Brackets and projections.....	44			

NOTE

The products and assembly variants shown in this document may be subject to country-specific regulations. The user of the products bears the responsibility for compliance with these regulations. Subject to local regulations, we reserve the right not to supply all the products illustrated here.

Your Layher partner on the spot will be happy to provide advice and answers to all questions relating to the products, to their use and approvals, or to specific assembly regulations.

The contents of this document relate exclusively to original Layher scaffolding components. Layher has prepared these contents, in particular the specifications, presentations, data, computations, directions and recommendations, with the utmost care. Nevertheless, Layher cannot accept any liability for the correctness, completeness and currentness of the contents. Where legally permissible, liability shall be excluded unless Layher is acting with intent. This applies in particular for obvious mistakes, typing errors, calculation errors and printing errors. Use of the contents shall be at the user's own risk. Information on structural loading capacity has been prepared by Layher to the best of its knowledge and belief on the basis of the relevant technical regulations or other sets of regulations. This information relates to the exclusive use of original Layher scaffolding components. The scaffolding designs as shown, the detailed solutions and the intended uses must be understood only as non-binding examples. The users of the scaffolding components must, whenever they assemble scaffolding, prepare and document their own structural strength calculations, taking into account the design, the local conditions and the local requirements. The country-specific and relevant requirements, provisions and regulations applying at the respective place of use must be checked on the users' own responsibility. If Layher offers type-tested structural analyses for defined scaffolding structures or scaffolding components, their applicability must be checked in each individual case.

If components from other manufacturers are used in scaffolding structures, these instructions for assembly and use are not applicable.

1. INTRODUCTION

General

These instructions for assembly and use relate to assembly, modification and dismantling of some of the assembly variants of the Allround Scaffolding from Wilhelm Layher GmbH & Co KG, of Göglingen-Eibensbach, Germany. These instructions cannot cover all the possible applications. General information is provided.

The suitability of the scaffolding to be assembled for its intended purpose, taking account of the effects, the load class and the width class in particular, must be verified.

The scaffolding erector must ensure that all reasonably predictable risks to health and safety are recognised during assembly, use and dismantling of the scaffolding. If any risks are detected, suitable preventive measures must be taken and checked by the scaffolding erector. The present instructions for assembly and use do not release the scaffolding contractor from the obligation to conduct his own risk assessment for the respective location and for the respective working method. If you have any questions about specific applications, please contact your Layher partner.

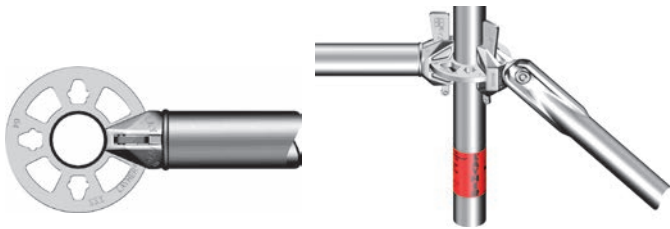

Fig. 1: Layher Allround LW acc. to Z-8-22-939

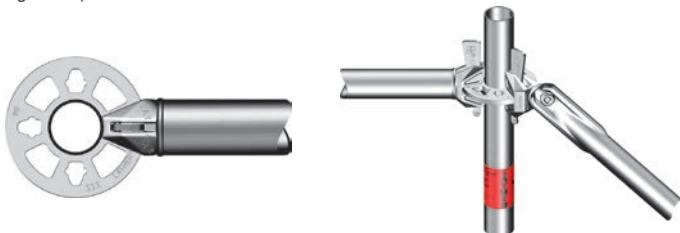

Fig. 2: Layher Allround Steel acc. to Z-8-22-64

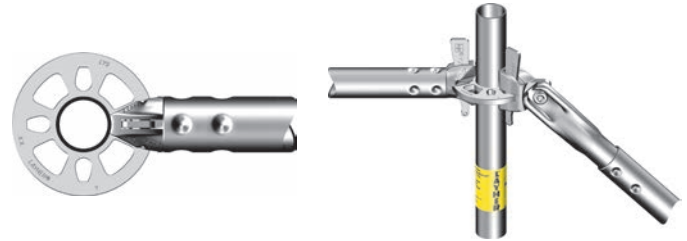

Fig. 3: Layher Allround Aluminium acc. to Z-8-22-64.1

Caution: The stability of the scaffolding must be assured at all times, including in the assembled state. The employer responsible for the scaffolding construction work, or a qualified person appointed by him, must draw up a plan for the assembly, use and dismantling of the scaffolding, depending on its complexity. The present instructions for assembly and use can be used to do so, supplemented by detailed specifications for the respective scaffolding. This plan, with all the instructions it contains, must be available to the qualified person supervising the scaffolding construction work and to the employees concerned before the start of such work.

The contents of these instructions relate to scaffolding structures in which exclusively original Layher scaffolding components are used. Original Layher components for Allround Scaffolding are identified with the conformity mark <Ü> and the abbreviated approval number in accordance with the requirements of the building authority approvals Z-8.22-64, Z-8.22-64.1 and Z-8.22-939.

Scaffolding components must be checked for visible defects prior to their installation. Do not use damaged components. When assessing whether a scaffolding component is damaged or not, the respective use of the individual component may be taken into account. For example, a rosette split into parts on an Allround standard has no effect on the standard's load-bearing capacity. Instructions on the assessment of possible damage to robust decks can be found in our "Repair instructions for robust decks".



Fig. 4

During assembly, modification and dismantling of Layher Allround Scaffolding, non-compliance with the present instructions for assembly and use and with the respective working safety regulations can lead to a risk of falls. Assembly situations where there is a risk of falls are indicated in these instructions with the adjacent symbol inside the assembly pictures.

The scaffolding erector must assess the risks involved (risk assessment) before the start of assembly work, and devise suitable protective measures from it. This must include risks that arise from both the use of the scaffolding itself and from the respective working environment. The result of the risk assessment must be documented. The measures arising from the risk assessment form the basis for performing the scaffolding construction work and must be adopted in the assembly instructions.

The protective measures to be taken are based on the actually existing risk, on their expediency and on practical possibilities, and depend on:

- the qualification of the employees,
- the type and duration of the activity in the high-risk area,
- the possible fall height,
- the state of the surface onto which the employee might fall,
- the state of the workplace and its access, and
- the local regulations.

Technical, organisational and personnel-related protective measures can be applied during assembly, modification and dismantling. The selection and the ranking of the measures are based on the respective regulations and on possibilities. Possible measures can, for example, depending on the assembly situation include the use of qualified personnel specifically informed about the respective risk situation, the use of an advance guardrail, or the use of suitable personal protective equipment against falls for scaffolding construction. In any event, the assembly sequence must be designed such that side protection is installed at once, so that personnel work predominantly in secured areas. If the use of personal protective equipment against falls (PPE), of an advance guardrail or of a combination of these is required or is specified by local regulations when assembling scaffolding,

the attachment points shown in section 2 or the advance guardrail described there must be used. The suitability of the equipment as a protective measure must be checked in respect of the required clearance underneath the attachment point, particularly for the assembly of the second and third scaffolding levels.

Also, before scaffolding work starts the contractor must ascertain whether the intended work area contains any site-related risks arising from equipment, overhead cables, other work in progress, falling parts, road traffic or other risks due to burying or sinking etc., that might endanger employees.

Risk	Possible protective measure
Splitting off / airborne parts	Safety glasses
Falling parts	Hard hat
Sharp edges	Gloves
Weather effects	Weather-appropriate clothing
Stubbing / pointed objects / twisting ankles	S3 safety shoes
Dust	Dust mask
Noise	Ear protectors
Falls	PPE and / or AGR

Assembly, modification and dismantling of Layher Allround Scaffolding may only be performed with appropriate protective equipment.

Scaffolding components must not be thrown; instead they must be passed along in such a way that they cannot slip or be dropped. The use of lifting gear must be checked.

After completion of the assembly work and before every use of the scaffolding, a check must be conducted to ensure it is in good condition. With regard to the following sections of these instructions for assembly and use, it must again be pointed out that scaffolding may only be assembled, modified or dismantled under the supervision of an expert person by technically trained employees who have been appropriately and specifically instructed in this work. To that extent, and with regard to use, we refer to the requirements of the German

occupational safety regulations applicable at the respective location of the scaffolding. With the present instructions for assembly and use, we provide the erector and the user, on the basis of our risk analysis, with advice on how to comply with the requirements of the above safety regulations (BetrSichV) in the respective assembly situation.

The protective measures and assembly sequences described in these instructions for assembly and use are intended to help the erector and/or user to comply with the requirements of working safety regulations but are not mandatory specifications for them. The erector/user must take the measures needed on the basis of a risk assessment, prepared according to the preconditions of the respective working safety regulations, at his own discretion and exercising all due care and diligence. The specific features of the individual case must be taken into account here.

It is essential that the present instructions for assembly and use are complied with in every case. It must be pointed out that all information in the instructions for assembly and use, in particular that on the stability of the assembly variants, applies only when original Layher components are used that are identified in accordance with the requirements in the aforementioned approvals stated on page 4. The installation of components made by other manufacturers can lead to safety defects and insufficient loading capacity and stability. The present instructions for assembly and use must be available to the qualified person supervising the scaffolding construction work and to the employees involved at the start of such work. During assembly, modification and dismantling, as well as during use of the scaffolding, the national legal regulations concerning scaffolding structures and occupational safety during erection and use of such scaffolding must be complied with.

Inspection and documentation

The scaffolding erector must ensure that the scaffolding is, after completion of the assembly work and before transfer to the scaffolding user, checked by a person qualified to do so to ensure that it has been correctly assembled and is safe to use. The inspection must be documented. If certain parts of scaffolding are not usable, in particular during assembly, dismantling or modification, such parts must be identified with a prohibition sign indicating “no entry” and marked off by barriers preventing access to these parts.

After completion of the scaffolding, it is useful to indicate that inspection has been passed by a clearly discernible identification on the scaffolding itself for the duration of its use. This identification should include the following information:

Example for identification:

- Work scaffolding to EN 12811-1
- Width class W06 and load class 3
- Evenly distributed load max. 2.0 kN/m²
- Date of inspection
- Name of scaffolding company
Postcode and city, Telephone number

Use



Fig. 5



Fig. 6

Every employer who requires personnel to use the scaffolding or parts of it must, in the course of the risk analysis, determine whether an inspection prior to use is required. The inspection is intended for confirmation of safe operation depending on the respective use of the scaffolding. After any unusual events that might have damaging effects on the safety of the scaffolding, the employer using it or

causing it to be used must immediately ensure that an unscheduled inspection is performed by a qualified person to do so. This person must ensure that the scaffolding is checked for obvious defects before use. The employee causing scaffolding to be used is responsible for preserving its operational safety.

If defects are found during this check, the scaffolding must not be used in those areas where there are defects until these have been eliminated by the scaffolding erector. Subsequent alterations to the scaffolding are deemed as assembly, modification or dismantling and may only be performed by technically trained employees. If the scaffolding is used by several employers, simultaneously or successively, each employer must ensure that the aforementioned inspection is conducted.

The legal regulations of the German ordinance relating to the redefinition of requirements for occupational health and safety in the use of work equipment and hazardous materials (BetrSichV) must be complied with. Further information on occupational safety can be found in "DGUV-Information 201-011" (instructions for handling and using work and protective scaffolding).

The basis for Allround Scaffolding approvals in Germany are German and European standards. Allround Scaffolding has been approved in many other countries and conforms to British Standards.

Caution: Differing and supplementary local regulations are not taken into account in these instructions, but must be complied with.

A detailed list of articles can be found in our catalogue, and information on structural values in our technical documents.

Layher Allround Scaffolding may be used as work scaffolding and protective scaffolding according to the stated load classes, and in compliance with the present instructions for assembly and use and with the stipulations in BetrSichV.

2. MEASURES FOR FALL PROTECTION

2.1 Fall protection during assembly, modification or dismantling of the scaffolding

General

In line with locally valid occupational safety laws and regulations, or as the result of a risk assessment conducted by the scaffolding erector, the use of personal protective equipment (PPE) against falls, of an advance guardrail, of a combination of both of these, or of another adequate and higher-level protective measure such as section-by-section assembly or complete decking of all scaffolding levels, can for example become necessary when assembling, modifying and dismantling the scaffolding. The risk assessment should be conducted such that the resultant protective measures are practicable and suitable for the work to be done at the location. Any local requirements or project-specific results of the risk assessment that either demand or rule out the use of certain protective measures must be taken into consideration.

Attachment points for personal protective equipment (PPE) against falls

If the use of PPE is intended for assembly, modification and dismantling of Allround Scaffolding, use the attachment points shown in Figs. 8 to 12. The attachment points shown have been verified by drop tests with original Layher Allround Scaffolding. If Allround Scaffolding uses components not identified in accordance with the specifications of the building authority approvals Z-8.22-64, Z-8.22-64.1 and Z-8.22-939, the suitability of the attachment points for using PPE must be verified separately by the scaffolding erector / constructor.

WARNING

During assembly, modification or dismantling of scaffolding, the erector must be secured at a point which is not part of the scaffolding bay being assembled or dismantled (i.e. independent of it).

Attachment points for PPE must be chosen that are as high as possible, and they must not be underneath the deck level. When the hook is attached to the large or the small hole in the steel rosette (Fig. 9) or to the standard tube above the rosette (Fig. 8), it can in the event of a fall be subjected to bending stress. The Layher PPE flexible connecting line 2.00 m (Ref. No. 5969. 501) is suitable here. If PPE from another manufacturer is used, check whether it can be attached in this way. With a steel bridging ledger, attachment can be to both the upper U-/O-section and to the round tube of the under-bracing.

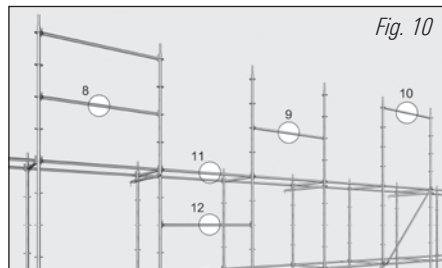
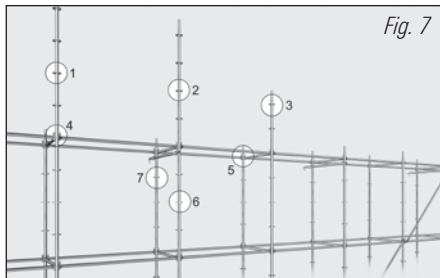

Fig. 9: Attachment in large and small hole of rosette possible
(Only permissible in Allround Scaffolding in steel – not in Allround Scaffolding in aluminium)

Fig. 10: Attachment points to Allround O-/U-ledgers; maximum bay length 3.07 m



Fig. 11: Attachment to an O-ledger (U-ledger similar, where attachment is possible)

1, 2, 3	To a standard going all the way through at the height of the scaffolding level and without a joint, not more than 1 meter above the scaffolding level.
4, 5	To a rosette at the level of the ledgers. The ledgers must be already fitted.
6, 7	To any rosette inside a completely assembled scaffolding layer.
8, 9, 10	To an O-ledger max. 2 m above the completely assembled scaffolding level. Standards projecting 2 meters above the scaffolding level are shown; connection of the ledger to vertical standards projecting by 1 meter is also permissible.
11, 12	To a ledger inside a fully assembled scaffolding level.

If PPE is used, adequate clearance must be provided underneath the system so that the person using it does not hit the ground or an obstacle located underneath the system in the event of a fall. If it is not possible to eliminate all the obstacles, the fall protection system must be selected and used such that the risk of injury for the person using it is minimized. The drop height depends on the equipment used and on the relative position of the attachment point from the secured person. A complete check of all factors that can affect the drop height must be conducted, and suitable precautions taken for the remaining clearance.

WARNING

If the clearance between the attachment point and the possible impact point is less than that required, there is a risk of severe or fatal injury. If PPE with a connecting line at least 2 m long is used in the second scaffolding level, there is a risk of injury in the event of a fall.

When PPE systems approved and type-tested specifically for scaffolding construction work are used, with 2.00 m long **PPE connecting means and PPE belts with strap extension**, the attachment point must be at least 1.00 m above the standing surface.

If **PPE straps without strap extension** and 2.00 m long PPE connecting means are used, attachment can also be to the intermediate ledger (50 cm) or at the level of the platform surface to either the ledger or the standard. Attachment at a lower point is not permissible. The necessary clearance between the attachment point and the possible impact surface is for:

PPE systems with strap extension

- a1) when attached overhead: at least 5.25 m (Fig. 12)
- a2) when attached at guardrail level: at least 6.75 m (Fig. 13)

and for

PPE systems without strap extension

- b1) when attached overhead: at least 4.75 m (Fig. 12)
- b2) when attached at guardrail level: at least 6.25 m (Fig. 13)

If a fall is arrested, the person falling might suffer suspension trauma if fall protection equipment is used. Both scaffolding erectors and emergency personnel must be trained in rescue measures and able to detect suspension trauma and take appropriate measures without delay.

For selection, use and maintenance of fall protection systems, please refer to european and national regulations.

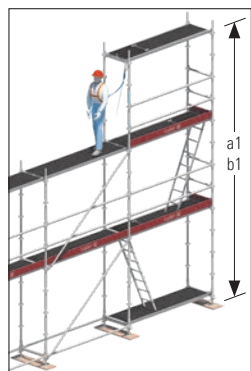

Fig. 12: Attachment overhead

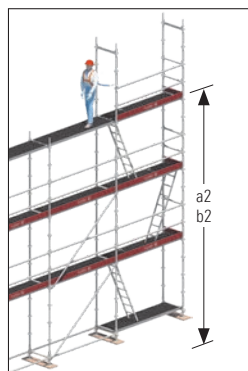

Fig. 13: Attachment at guardrail level

WARNING

The instructions for assembly and use of the PPE of the manufacturer must be followed. Safety harnesses and safety belts must conform to valid national regulations and requirements and be checked and used in accordance with them.

Advance guardrail system from Layher

One possible technical safety measure to prevent risks during ascent to the top scaffolding level and during assembly of this level is to secure it level temporarily using the advance guardrail system (AGS).

How the Layher advance guardrail system (AGS) works

The Layher advance guardrail system consists of two basic components – the advance guardrail post and the telescoping guardrail. The advance guardrail post a) or b) must be used depending on local regulations.

- a. Advance guardrail post with connection for telescoping guardrail at 1 m height
- b. Advance guardrail post with connection for telescoping guardrail at 0.50 and 1 m height
- c. Telescoping guardrail of aluminium, for bay widths of 2.57 m to 3.07 m and also for combined bay widths (e.g. 1.57 m and 1.09 m) by bridging a standard axis

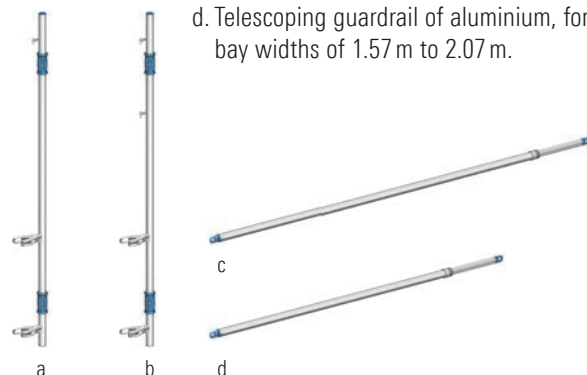

- d. Telescoping guardrail of aluminium, for bay widths of 1.57 m to 2.07 m.



Fig. 14: Use of the AGS in the access bay



Fig. 15: Detail of assembly of the AGS in the access bay

The Layher AGS can be conveniently repositioned from above or below for an end scaffolding closure (end AGS). It can be used for an end bay width of up to 1.40 m. For use on the first scaffolding level, an O-ledger must be installed on the first level as an end rail.

While standing on the secured topmost level, the erector of the scaffolding presses the top cross-rung of the end AGS downwards with his foot to release the top U-section. Then he swings out the end AGS, moves it upwards, and places it with the lower U-section on the installed handrail (O-ledger). Now he has to pull the lower cross-rung downwards until the upper U-section can be swung underneath the U-/O-ledger of the deck level. Releasing the cross-rung then locks the end AGS. To dismantle the scaffolding, the erector releases the upper U-section, from a secured level, by pulling down the lower cross-rung,

and then swings the end AGS outwards, moves it downwards and places it with the lower U-section on the guardrail of the scaffolding level underneath. Now he has to press the upper cross-rung downwards with his foot until the upper U-section can be swung underneath the U-/O-ledger of the deck level. The end AGS is secured by releasing the cross rung.



Fig. 16: Use of end AGS

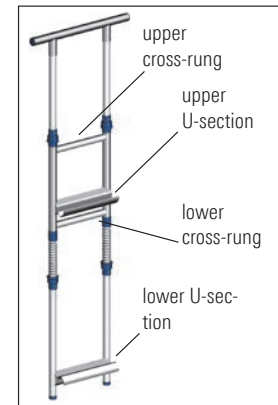

Fig. 17: Details of end AGS



The advance guardrail post of the AGS can be fitted and dismantled by one erector from two positions:

1. Fitting / dismantling from above
2. Fitting / dismantling from below

It must be ensured that both claws of the AGS snap in completely and that the telescoping guardrail is attached using the tilting pins.

Fig. 18: Connection of advance guardrail system post to vertical standard

For further instructions on using, maintaining and caring for the Layher advance guardrails (AGS and end AGS), please refer to the instructions for assembly and use of "AGS (advance guardrail system)".

2.2 Fall protection during work on the scaffolding

Unless local regulations specify otherwise, the three-part side protection comprising top rail, intermediate rail and toe board must be installed on the outside of the scaffolding at all working levels in use. The three-part Allround side protection (see Fig. 19) meets the requirements for side protection components as per EN 12811-1. The minimum guardrail height of 95 cm must be complied with when standard decks are used. Country-specific regulations must be complied with.

When scaffolding planks are used on standard decks, a third ledger at the 1.50 m level ensures the minimum guardrail height of 95 cm required by EN 12811-1.

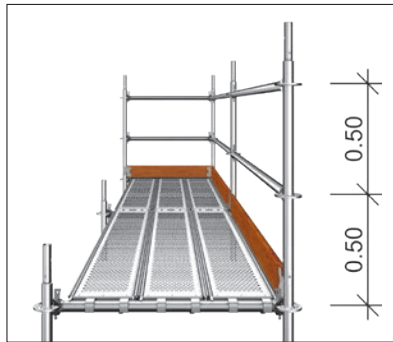

Fig. 19: Three-part side protection in Allround Scaffolding

If the maximum clearance (e.g. 30 cm) between the building wall and the outside of the deck level or horizontal scaffolding parts is exceeded, side protection may be needed on the inside of the scaffolding too. In individual cases, side protection may be needed for even shorter distances too. If work is to be performed on the facade, the assembly of the side protection must be checked.



Fig. 20: Toe board in U-section system



Fig. 21: Toe board in O-section system

3. GENERAL

3.1 Allround Scaffolding in steel and aluminium

Layher Allround Scaffolding is made of steel and aluminium. Steel and aluminium components have different load-bearing capacities. Steel and aluminium Allround Scaffolding can also be distinguished by the colour of the stickers (steel fluorescent red; aluminium fluorescent yellow). See also page 4.

Allround Scaffolding in steel: Variant II, K2000+ and LW

The following three variants must be distinguished:

a. Variant II
Made until 1999

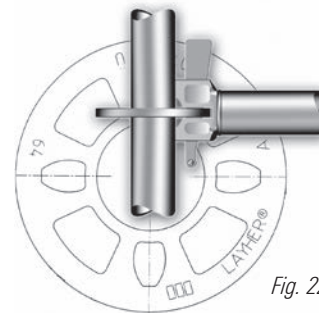

Fig. 22

b. K2000+
Manufacture from 2000 to 2013

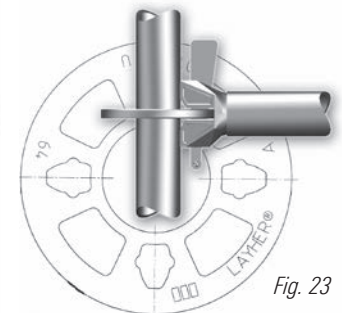

Fig. 23

c. Variant LW
Manufacture starting in 2013

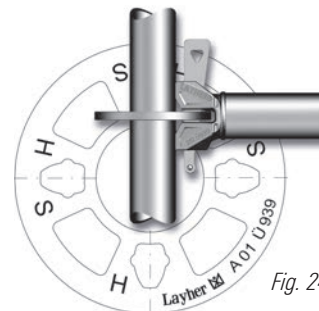

Fig. 24

All three variants have different load-bearing capacities, but can be used interchangeably. In these mixed structures, the lowest load-bearing capacities must be assumed as a rule. For more detailed information please refer to the Allround approvals Z-8.22-64 and Z-8.22-949.

The standards differ outwardly in the design of their "small" holes (Figs. 23 to 25) and of the spigot. The ledgers differ in the design of their wedge heads and wedges (Figs. 23 to 25). In the standards of the LW Series the rosettes have an HS stamp. The wedge heads of the LW components have an indentation on the side and their wedges have a triangular recess.

Allround Scaffolding in aluminium

Information on the load-bearing capacity can be found in the general building authority approval Z-8.22-64.1.

3.2 Function principle of Allround wedge connection

1. Slide the wedge head over the rosette.
2. Insert the wedge into a hole. The component is secure against shifting and falling out.
3. Hammer down the wedge to provide a non-positive connection (use metal hammer of min. 500 g until the blow bounces off).

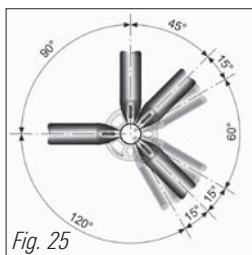
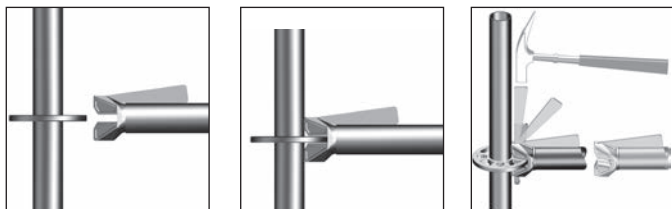

The rosette allows up to 8 components to be connected. When the components are connected using the small holes, they are automatically aligned at right angles or parallel to one another. In the large holes, the connection angles are variable.

WARNING

After installation, i.e. before the components are subjected to loads, wedges must be hammered home using a metal hammer of at least 500 g until the blow bounces in order to ensure a non-positive connection. The hammer from Layher can be used to do so. Metal hammers with a larger head are not suitable for knocking out wedges.

Inadvertent undoing of the connection of load-bearing component wedges (e.g. diagonal braces) when knocking out wedges must be prevented. Accidentally loosening connections of load-bearing components reduces the stability of the scaffolding structure and can cause it to collapse.



Scabbling pick
from Layher
600 g reinforced
Ref. No. 4421.051

AutoLock function

Allround O-ledgers LW feature the AutoLock function. The AutoLock function allows the assembly of O-ledgers, in particular of the guard-rail ledgers, from a secured level. Slightly turning the ledger moves the self-locking wedge into its assembly position. Upon contact with the standard, the wedge is activated and then drops by itself into the hole in the rosette. The positive connection achieved in this way secures the end of the ledger. The other end of the ledger is moved in the classic way above the rosette, and both wedges are then hammered home.

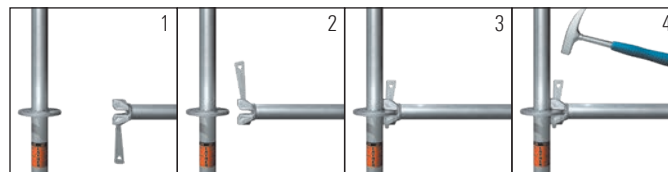

1. Rotate ledger before fitting.
2. Wedge head in fitting position.
3. Standard activated. Wedge drops into hole. Positive connection.
4. Non-positive connection.

3.3 Supplementing Allround Scaffolding with scaffolding tubes, couplers and wooden planks

Allround Scaffolding can be supplemented with the following parts:

- scaffolding tubes \varnothing 48.3 mm as per EN 39 with minimum wall thickness:
 - steel tubes: 3.2 mm
 - aluminium tubes: 4.0 mm
- scaffolding couplers as per EN 74-1 and EN 74-3
- scaffolding planks

Scaffolding tubes can be connected using scaffolding couplers to standards, ledgers, brackets, lattice beams and other Allround components. The exceptions to this are Allround vertical diagonal braces. Scaffolding couplers must not be fastened to these.

Scaffolding tubes connected using scaffolding couplers can have a load-bearing function, e.g. as bracket bracing, as lattice beam bracing or as an anchoring structure, and also be used for only secondary purposes.

WARNING

Incorrectly fitted scaffolding couplers reduce the stability of the scaffolding structure and can lead to its collapse.

Wedge couplers must be hammered tight using a metal hammer of at least 500 g until the blow bounces off. Screw couplers must be tightened with a torque of at least 50 Nm.

Over-tightened scaffolding couplers can damage scaffolding tubes.

Attach scaffolding couplers as per EN 74-1/-2/-3 only to round tubes with an external diameter of 48.3 mm.

Both steel planks and wooden planks can be used as scaffolding planks. They are used for bridging of the deck level in equalising bays or for closing openings in the work level. As with scaffolding decks, with scaffolding planks too the loads are transmitted in the longitudinal direction of the planks. As a rule, scaffolding planks are laid on scaffolding decks, but can also be laid directly on the ledgers.

When scaffolding planks are used, there may be a shortfall from the minimum guardrail height of 95 cm as per EN 12811-1. It may be that a third ledger has to be installed. If wooden planks replace scaffolding decks in the deck level, the scaffolding must be stabilised by fitting horizontal diagonal braces directly underneath the plank level or implementing other stabilisation measures. Scaffolding planks must be secured in position.

Steel planks have the advantage over wooden ones that they do not increase the fire risk at their place of use. Layher steel planks can be secured against being lifted out or slipping using, for each support, two plastic locking pins (3800.006), two steel bolts (3800.007) or one locking screw, long (3800.009, 3800.010) on steel or perforated aluminium decks. Locking pins can only be used once. At the support, a minimum projection of 10 cm is sufficient with the steel plank. The permissible spans and the load classes correspond to those of the steel deck matching them in length (see for example Z-8.22-64).

When wooden planks are used, the maximum spans and other criteria for use, such as plank thickness, as per local regulations such as DIN 4420-3, must be complied with. Planks must be secured by others against inadvertent lifting off and shifting. Wooden planks can be mounted, in the case of Allround Scaffolding, on the transoms and on additional support ledgers (Fig. 26) and arranged overlapping or abutting. During mounting, a minimum projection of 20 cm is recommended, and with an overlap a minimum coverage of 40 cm.

Fig. 26: Wooden planks laid abutting

Fig. 27: Wooden planks overlapping

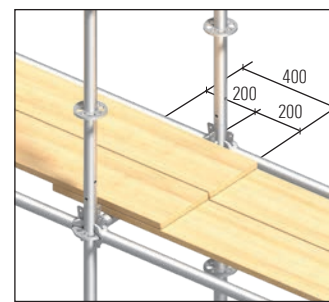
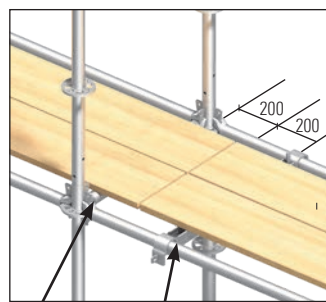

Transom Additional support ledger

3.4 Important assembly directions

Work on the scaffolding must always be performed wherever possible on a completely assembled and secured level. If temporary planks are used during scaffolding assembly and are not laid over the full surface of the scaffolding bay, there will be, in addition to the general risk of falls, also the risk of falls due to slipping or instability of the temporary planks unless they are secured to prevent inadvertent lift-out and shifting. Appropriate protective measures must be taken.

WARNING

Wedges must be hammered home immediately after assembly of the components using a metal hammer of at least 500 g until the blow bounces off.

Wedge couplers must be hammered tight using a metal hammer of at least 500 g until the blow bounces off. Screw couplers must be tightened with a torque of at least 50 Nm.

Scaffolding may only be erected on sufficiently strong surfaces. Before assembling Layher Allround Scaffolding, the surface must be checked for sufficient load-bearing capacity. Suitable load-distributing supports must be selected.

The maximum spindle extension lengths must not be exceeded. One-sided positioning of the base plate can cause excessive stresses in its cross-section and collapse of the scaffolding.

The stability of the scaffolding must be assured at all times, including in all assembled states.

Anchoring must be installed continually as scaffolding assembly progresses. If necessary, stability must be assured by ballasting or bracing.

Scaffolding decks must be secured against inadvertent lifting out, for example due to wind forces. In scaffolding where scaffolding decks double as bracing elements, the latter must be installed over the full scaffolding width and secured against lift-out by lift-off preventers.

No personnel or loose objects may be on rolling towers when these are being moved. The wheels of the rolling tower must always be locked and only released to move it.

Inadvertent removal of wedges in load-bearing components can lead to a collapse of the scaffolding and the risk of serious injuries or fatalities.

Corrosion resistance

1. Scaffolding parts made of galvanized steel

Layher scaffolding components made of steel are largely protected from corrosion by a hot-dip galvanizing process with zinc coating thicknesses of 60 to 80 μm . This high zinc coating thickness ensures a very long service life when the components are used in moderately polluted urban and industrial atmospheres and in coastal areas with low salt exposure. The zinc coating is, in this case, only degraded very slowly (about 0.7 to 2.1 μm a year, as per DIN EN ISO 12944), so its protective effect is correspondingly long-lasting. In this case, special measures to prevent corrosion are not normally necessary. In industrial areas with aggressive atmospheres and in coastal or offshore areas with high salt exposure, the zinc coating will degrade at a faster rate (about 4.2 to 8.4 μm a year, as per DIN EN ISO 12944), so the protective effect of the zinc coating will be correspondingly shortened. Direct contact with aggressive media (e.g. acid) too might damage the zinc coating and lead to premature corrosion. When the components are used in these aggressive atmospheres, the scaffolding erector must arrange for suitable checking measures to inspect the components and to monitor the development of corrosion.

2. Scaffolding components made of aluminium

Aluminium surfaces form natural oxide coatings which largely protect the scaffolding components from corrosion. This oxide coating is resistant in the chemically neutral range (pH 5 – 8). In industrial areas with aggressive atmospheres and in coastal or offshore areas with high salt exposure, as well as in cases of direct contact with acids or alkalines, visible surface defects, material degradation and hence a shortened service life of the components must be expected. When the components are used in these aggressive atmospheres, the scaffolding erector must arrange for suitable checking measures to inspect the components and to monitor the development of corrosion.

3. Direct contact of scaffolding components made of different metals

If components made of different metals (such as aluminium and galvanized steel) are in a direct conductive connection to one another and if a liquid medium (electrolyte, e.g. salt water) is additionally present, there is a risk of contact corrosion. With this corrosion type, the less noble metal corrodes. This can occur for example in coastal /

offshore areas when scaffolding couplers are attached to aluminium lattice beams. There is a risk here that aluminium can deteriorate underneath the scaffolding coupler without this being visible. When the components are used in these aggressive atmospheres, the scaffolding erector must arrange for suitable checking measures to inspect the components and to monitor the development of corrosion.

If scaffolding components are used in the corrosion-promoting environments described above, the responsibility for any consequences associated with them lie with the scaffolding erector.

- ▶ Layher scaffolding components are corrosion-resistant for many years under normal atmospheric conditions.
- ▶ When used in industrial areas with aggressive atmospheres and in coastal or offshore areas with high salt exposure, or in cases of contact with aggressive media, scaffolding components can corrode faster than under less aggressive conditions.
- ▶ If components made of different metals are in a direct conductive connection to one another, there is a risk of contact corrosion (for example in offshore applications in the pairing “galvanized steel / aluminium”).

Frost resistance

Allround Scaffolding components are frost-resistant unless water has pooled inside the components. Pooled water can, in frost conditions, cause tubes to crack as a result of expansion. To prevent that, either the ingress of water into the tubes must be prevented, for example by plugging the top ends of the standards with plastic caps, or sufficient water drainage must be assured. Allround standards embedded in concrete are particularly at risk.

4. BASIC COMPONENTS OF LAYHER ALLROUND SCAFFOLDING

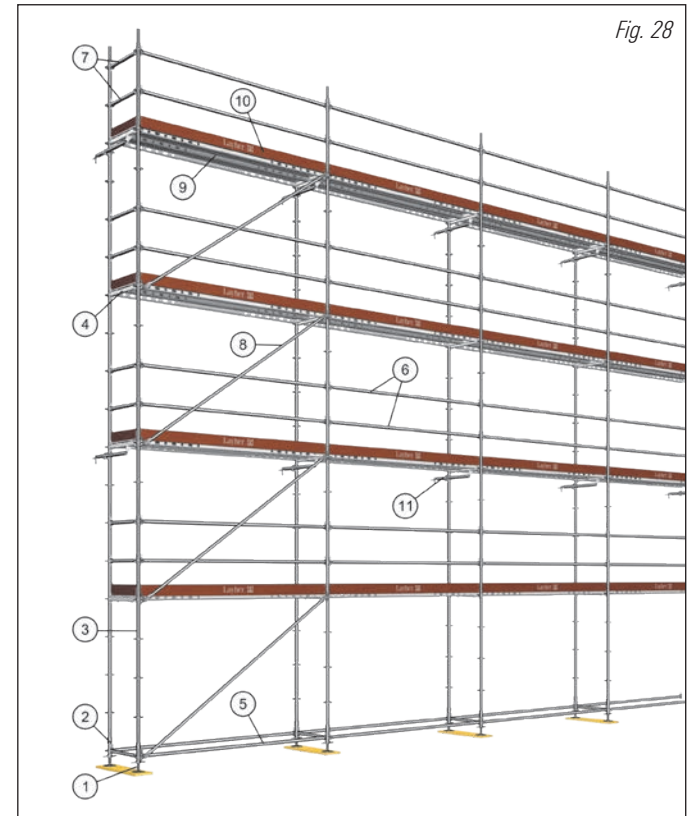

Fig. 28

- 1 Base plate
- 2 Base collar
- 3 Standard
- 4 Support ledger (U-ledger or O-ledger)
- 5 O-ledger
- 6 Guardrail (O-ledger)
- 7 End guardrail (O-ledger)
- 8 Vertical diagonal brace
- 9 O- / U-scaffolding deck
- 10 Toe board
- 11 Anchoring

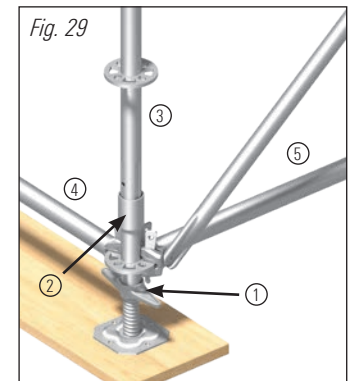

Fig. 29

4.1 Base plates

Base plates must be in full surface contact. If necessary, they must be secured against slipping / sliding.

WARNING

One-sided positioning of the base plate can cause excessive stresses in its cross-section and collapse of the scaffolding.

4.2 Spindle type and spindle extension length

Adjustable base plates with the largest maximum spindle adjustment may be used provided their load-bearing capacity is verified in each case. Base plates must be extended no further than their notch to ensure the specified overlap length. If the surface is not level, swivelling base plates, wedge-type inserts or equalising plates for base plates (4000.400) must be used and secured against sliding. For further information about this please refer to the Layher technical brochure.

Load-bearing capacities of spindle cross-section as per DIN EN 12811-1

Spindle type	N_{Rd} [kN]	M_{Rd} [kNcm]	V_{Rd} [kN]
normal	97.7	83.0	36.0
reinforced	119.9	94.5	44.1
solid	288.0	157.0	106.0

4.3 Base collars

The base collars with rosette are placed over the height-adjustable base plates and are intended to provide the base point. Base collars interconnected using ledgers increase the load-bearing capacity of the standards. Where standard loads are low, the use of base collars can be dispensed with in some cases. In rolling towers or aluminium scaffolding, the use of long base collars (2660.000) is recommended.

4.4 Standards

The Allround standards are provided with rosettes every 50 cm. They are available in the lengths 0.50 m, 1.00 m, 1.50 m, 2.00 m, 2.50 m and 3.00 m. The small openings in the rosette determine right-angled connections, while the larger openings permit connections at any angles.

Connecting two standards is achieved using spigots and, where necessary, the connecting means Special bolt M12 x 60 with nut or hinged pin dia. 12 mm. Depending on the type of standard, three spigot types are distinguished:

- Standard with press-in spigot (up to and including variant K2000+, Fig. 30 a)
- Standard with or without bolted spigot (Fig. 30 b)
- LW standard with integrally cast spigot (Fig. 30 c)

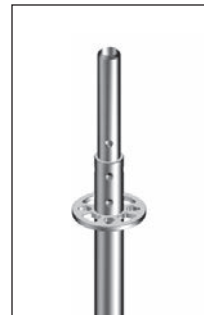

Fig. 30 a



Fig. 30 b



Fig. 30 c

Depending on application, the standard with bolted spigot (Fig. 30 b) both without spigot, e.g. in surface scaffolding, and with spigot, e.g. in structures subject to tension, can be used. When this type of standard with spigot is used, the spigot must always be connected to the upper end of the standard using two special bolts M12 x 60 with nut. The nuts must be tightened using an appropriate tool (see Fig. 32). The two bolts, arranged opposite one another, ensure a practically rigid connection and permit the transmission of bending moments. Before installing a standard with bolted spigot, check that the nuts have been firmly tightened.

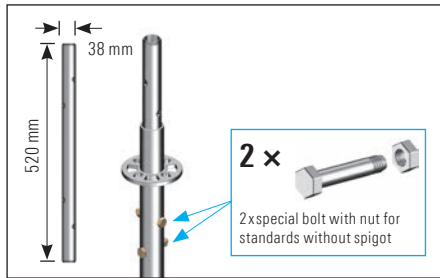

Fig. 31: Fastening of the spigot with two special bolts M12 x 60 and nuts

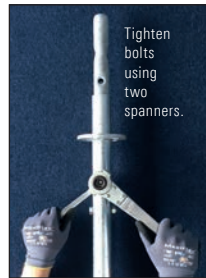

Fig. 32: Tighten the nuts using a suitable tool.

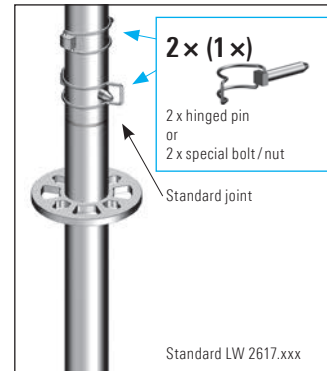

Fig. 33a: Tensile joint with LW standard

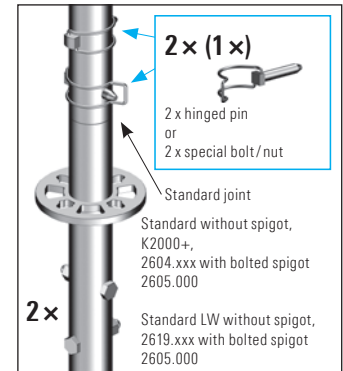

Fig. 33b: Tensile joint with bolted spigot

⚠ WARNING

The nuts of the special bolts M12x60 must be firmly tightened. Nuts not firmly tightened can become loose and cause considerable damage. Firm seating of the nuts must be checked before the standard is installed. An absent bolt when the spigot is connected to the top end of the standard reduces its load-bearing capacity and increases the play inside the standard joint.

To transmit tensile forces on standards, for example in suspended scaffolding, free-standing scaffolding or ballasted enclosing structures, only standards with bolted spigot or LW standards must be used. For information on load-bearing capacities please refer to the Layher technical brochures. Standards with press-in spigot are suitable only for transmitting low tensile forces of up to $Z_{Rd}=10.0$ kN (\triangleq actual tensile force $Z_{RK}=6.7$ kN).

In the case of Allround standards subject to tensile stresses, the bottom standard ends of the upper standard must be connected with hinged pins or special bolts M12x60 with nuts to the spigot of the lower standard (see Figs. 33a and 33b). As already indicated, the nuts must – if the special bolts are used – be firmly tightened. Depending on the level of the tensile stress, the tensile joint can also be designed with only one bolt or one hinged pin, which does not however apply for the lower connection of the bolted spigot. In case of doubt, however, two connecting means must be provided in every case.

4.5 Ledgers

Ledgers are bracing elements, guardrails and supports for decks. The wedge head connection (for functioning principle see page 12) ensures positive and non-positive connection with central load introduction between standard and ledger. Information on the load-bearing capacity of the standard can be found in our Layher technical brochure. The suitability of the provided ledger for the respective use must be verified.

Ledger fitting – Variant 1:

See functioning principle of Allround wedge head connection on page 12.

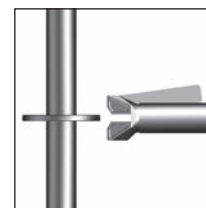

Fig. 34a

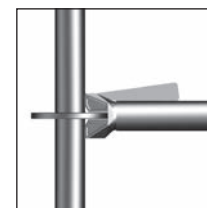

Fig. 34b

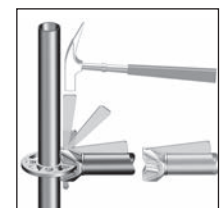

Fig. 34c

Ledger fitting – Variant 2: AutoLock

See page 12.

Ledger fitting – Variant 3:

This variant offers secure fitting for longer ledgers. The ledger end facing away from the erector is placed on the rosette with the wedge pushed through it. This safeguards the ledger against shifting. Slide the wedge head of the facing ledger end onto the rosette and push the wedge through. Pull out the wedge of the ledger head facing away, swing the wedge head over the rosette, and then secure it with the wedge. Knock in both wedges.

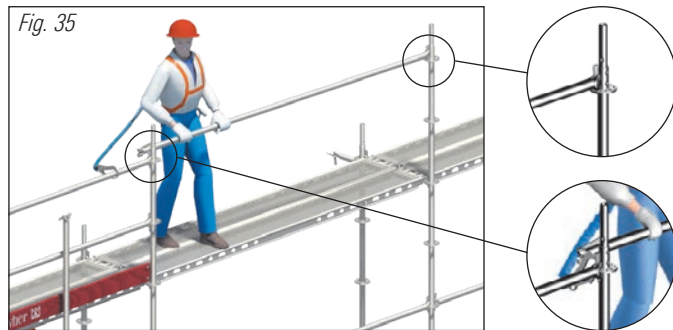

4.6 Scaffolding decks

Allround Scaffolding system decks – U-section and O-section

The scaffolding decks shown in these instructions for assembly and use are intended to act as examples and represent a cross-section from the Layher range. Further scaffolding decks can be found in the Allround approvals. The decks must be selected to sustain the planned loads. Information on the maximum load class or permissible loads on the decks can also be found in the Allround approvals or in our technical documents, e.g. in the Allround technical brochure.

In the case of Allround Scaffolding system decks, two basic suspension variants are distinguished. They result in differing support ledgers, brackets, bridging ledgers etc. The result is two modular scaffolding systems designated in the following as the U-variant and O-variant. All assembly sequences in these instructions are shown in the O-variant, and the assembly sequence for the U-variant is similar.

In the U-variant, a separate lift-off preventer is needed as an additional component to secure the decks if these scaffolding decks have to be safeguarded against lifting-out forces or inadvertent lift-out, or if the deck has a bracing function or transmits normal forces in the scaffolding structure. Regardless of the deck variants, it must be assured that the decks are always held firmly in or on the support ledger with all the suspension claws. If O-decks are to be placed on U-ledgers, which should only be done in exceptional cases, the integrated O-lift-off preventer cannot be activated.

U- and O-specific components are distinguished in their designations by the identifier “U” or “O” respectively (see section 23).

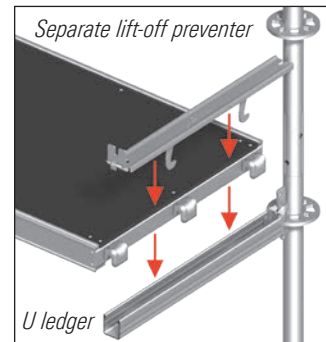

Fig. 36

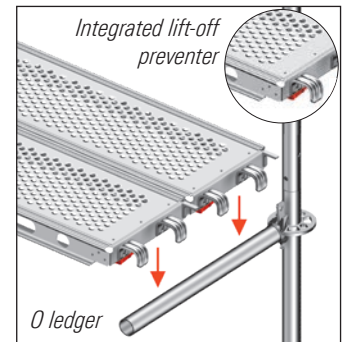

Fig. 37

If the design does not allow installation of the standard U-lift-off preventer, the decks can be secured with the “Universal U-lift-off preventer” against inadvertent lift-out.

U-lift-off preventer

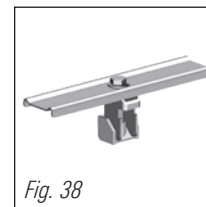

Fig. 38

Securing a single U-deck

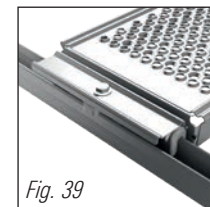

Fig. 39

Securing two U-decks at the same time

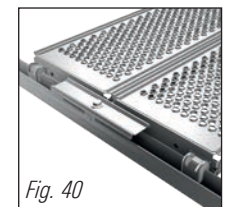

Fig. 40

The Universal U-lift-off preventer is positioned above the suspension claw of the deck and inserted into the U-section. The bolt / clamp mech-

anism permits rapid fitting and removal from above – turning the bolt clamps it inside the U-section and also secures the deck. It is possible to secure either every U-deck singly or two U-decks at the same time.

Installation of decks for mounting on O-sections

1. Swing back lift-off preventer.
2. Lay deck on the ledger.
3. Swing lift-off preventer forward.

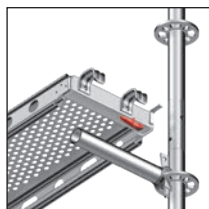

Fig. 41a



Fig. 41b

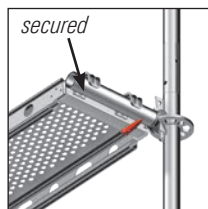

Fig. 41c

Installation of decks for mounting on U-sections

1. Lay deck inside U-section.
2. Tilt back movable end of lift-off preventer.
3. Place lift-off preventer inside U-section, inserting the hooks of the lift-off preventer into the recesses in the U-section.

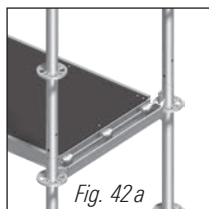

Fig. 42a

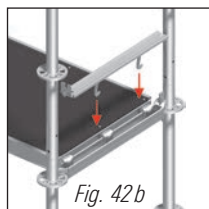

Fig. 42b

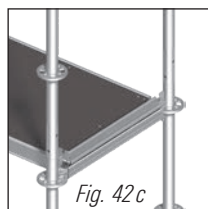

Fig. 42c

4. Move the lift-off preventer until the hooks engage.
5. Fold the moving end downwards.



left: Fig. 42d
right: Fig. 42e

⚠ WARNING

Scaffolding decks must be secured against inadvertent lifting out, for example due to wind forces. In scaffolding where scaffolding decks double as bracing elements, the latter must be installed over the full scaffolding width and secured against lift-out by lift-off preventers.

Depending on the selected support ledger length, it may be necessary to use combinations of decks with the widths 0.19 m, 0.32 m and 0.61 m for complete covering of the surface.

U-ledger deck configuration

Bay width Deck width	0.19 m		0.32 m		0.61 m		
	Variant	A	B	A	B	A	B
0.45 m	0	–	1	–	0	–	
0.50 m	2	–	0	–	0	–	
0.73 m	0	0	2	0	0	1	
1.00 m	3	–	1	–	0	–	
1.09 m	0	0	3	1	0	1	
1.29 m	1	1	1	3	1	0	
1.40 m	0	0	4	0	0	2	
1.50 m	2	–	3	–	0	–	
1.57 m	1	–	4	–	0	–	
2.00 m	0	3	4	4	1	0	
2.07 m	0	–	6	–	0	–	
2.50 m	0	4	5	5	1	0	
2.57 m	1	–	7	–	0	–	
3.00 m	2	0	6	9	1	0	
3.07 m	0	–	9	–	0	–	

Example: A 1.09 m wide bay can be covered with three 0.32 m decks (variant A) or one 0.61 m + one 0.32 m deck (variant B).

Decking:

Local regulations and statutory requirements tolerate differing gap dimensions between the decks (0 mm, 25 mm, 80 mm). The area between two adjacent bays, e.g. two scaffolding bays or one

scaffolding bay plus one bracket bay in particular, can be critical. To conform to the differing requirements, there are several possibilities for closing gaps:

- Telescoping gap decks for gaps between 40–255 mm (3881.xxx). The telescoping gap deck also braces the decks inside the scaffolding bay and prevents any shifting of the decks.
- Steel gap cover (3881.xxx) for gaps of up to 200 mm. Steel gap covers must be secured against slipping and lifting out like steel planks, but only with the short locking screw (3800.xxx).

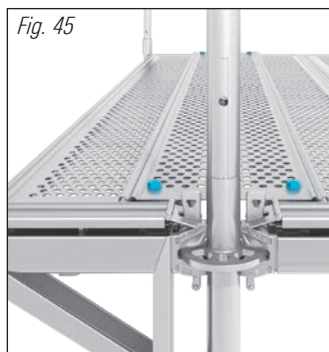
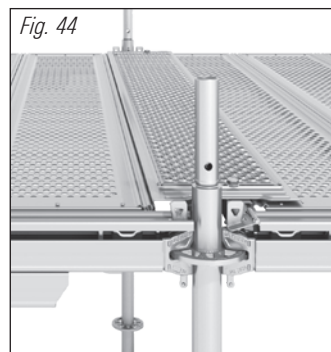

4.7 Diagonal braces

The diagonal braces with wedge head brace the basic system consisting of standards and ledgers, and thanks to their high connection values also permit strong and play-free scaffolding. The diagonal braces must be installed in accordance with structural strength requirements (Fig. 43).

NOTE

Diagonal braces should be fitted whenever possible to the outside of the scaffolding. This supports the use of horizontal advance guardrails and makes assembly of the work level easier. The risk of inadvertent loosening of the wedge during later dismantling is also reduced.

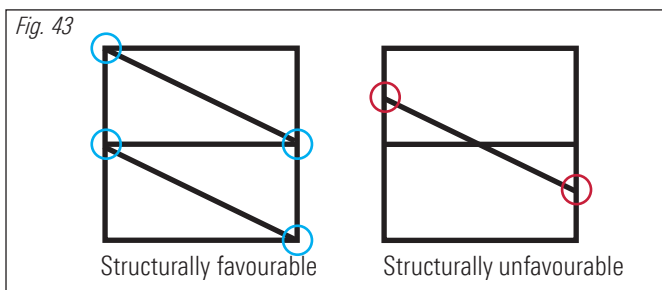

WARNING

Absent or incorrect installed diagonal braces lead to a reduction in the load-bearing capacity. Diagonal braces must be fastened wherever possible to braced connectors.

4.8 Toe board

The three-part side protection in the scaffolding bay and at the ends of the scaffolding is completed with toe boards. The fitting is positioned between standard and wedge.

Toe boards are available in wood, steel and aluminium. The example shown here is the U-toe board variant (all variants are also available as O-toe boards).



Fig. 46: Toe board wood in U-section system



Fig. 47: Toe board steel in U-section system



Fig. 48: Toe board aluminium in U-section system

Toe boards must be fitted as illustrated in the following.

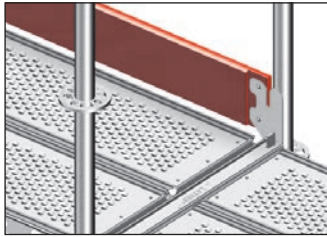

Fig. 49: Fitting the wooden toe board

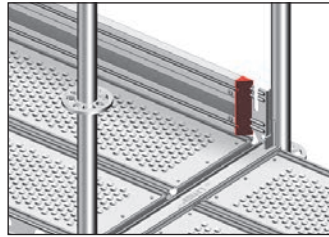

Fig. 50: Fitting the steel toe board

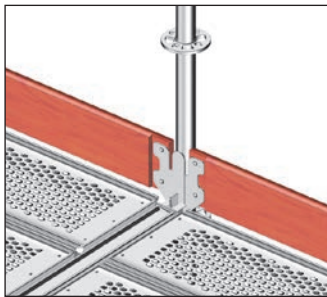

Fig. 51: Continuous toe boards

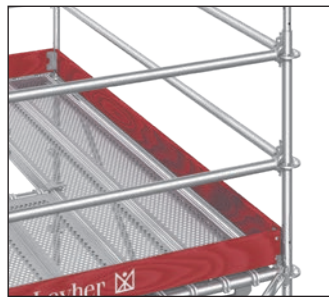

Fig. 52: Corner fitting of toe boards

For tower scaffolding the following installation sequence must be complied with. The following example shows the fitting of wooden toe boards.

1. First the two toe boards are installed in the longitudinal direction parallel to the decks.
2. The fitting of the toe board is mounted between the wedge and the standard tube. The cutouts (slots) in the fitting are aligned upwards for fastening the end toe boards. The Layher lettering is visible from the outside in all cases.

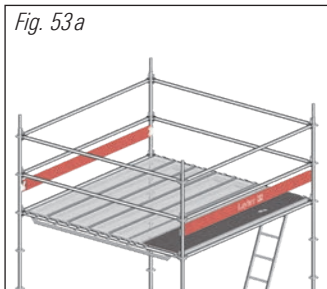

Fig. 53a

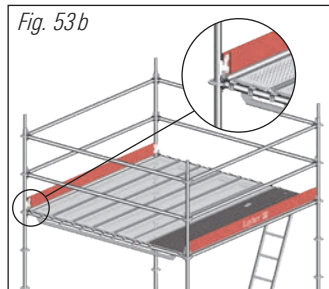

Fig. 53b

3. Then the end toe boards are fitted. Due to the insert connection, the toe board at the end must be rotated by 180°. The Layher lettering is upside down on the end toe boards (Fig. 53c).

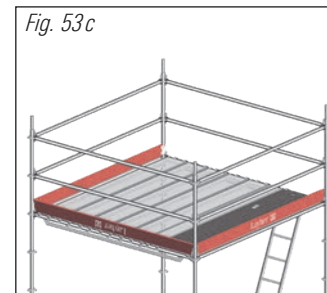

Fig. 53c

4. Toe board fitting is completed with the fourth toe board, which is installed at the end on the opposite side (Fig. 53d).

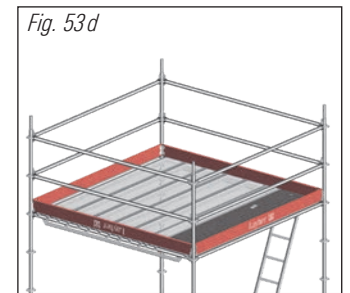

Fig. 53d

Toe boards must always be installed depending on the system. If this is not assured, the toe board height must be checked.

It must be checked individually whether the toe boards must be secured against lift-out by additional ones, to prevent the toe boards from being lifted out even in extreme wind situations.

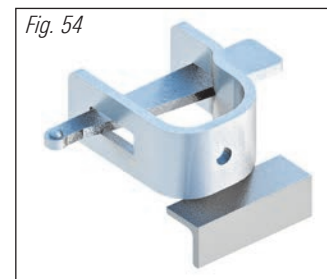

Fig. 54

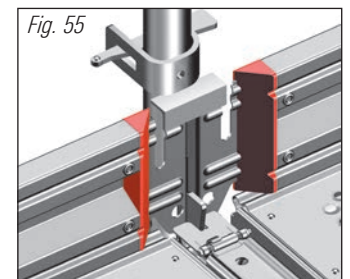
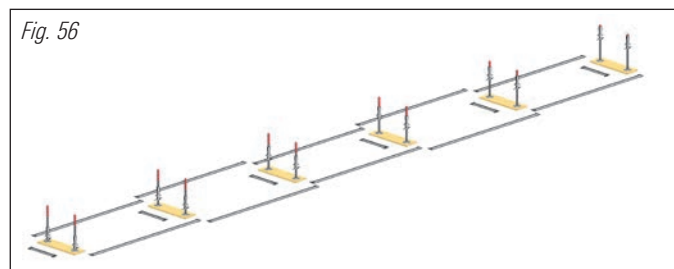

Fig. 55

5. FACADE SCAFFOLDING

Caution: Check the surface for sufficient load-bearing capacity and lay out suitable load-distributing bases. On sufficiently firm and strong ground, it is not essential that the scaffolding is mounted on continuous bases. The maximum spindle extension length must not be exceeded. When positioning, the maximum wall clearance must be ensured to prevent any risk of falls at the upper levels or between the scaffolding deck and the wall.



1. Assembly should be started at the highest point (see section 19). In the first step, longitudinal ledgers and transoms must be laid out.
2. Place load-distributing bases at the joints.
3. Position adjustable base plates with attached base collars on the load-distributing bases.
4. Connect ledgers in the small holes of the rosettes. Align the base frame of the facade scaffolding accordingly using a spirit level. To simplify alignment, installation of decks in the basic structure can be advantageous.

Caution: When positioning them, keep within the maximum wall clearance, otherwise there is a risk of falls.

5. Then insert decks in the access bay. If no decks are laid, the access ladder has no flat surface to rest on and could be damaged.
6. Fit vertical standards, install transoms. The standards are installed with their long projection downwards. The suitability of the support ledgers must be checked in particular in cases where they are more than 1.09 m or with high load classes (see technical brochure).
7. Insert decks, secure them against lifting out, and stiffen the scaffolding with vertical diagonal braces. Stiffen at least every fifth bay with vertical diagonal braces. The diagonal braces should be fitted

preferably on the outside of the scaffolding (see section 4 and technical brochure).

8. If necessary, lay out temporary boards (see section 3).

9. Insert the access deck and the remaining steel decks, then close the lift-off preventer. Knock in the wedges. Ladder and cover should be snapped in place during transport.

5.1 Assembly of the further scaffolding levels

For scaffolding more than 8 m high (deck height above assembly surface), building hoists should be used for assembly, modification and dismantling, depending on the risk analysis. As an exception to this, hoists can be dispensed with if the scaffolding height is no more than 14 m and the overall length of the scaffolding is no more than 10 m. In manual handling, one employee should be in position on every level depending on which components are to be handled. The scaffolding levels intended for vertical transport must be provided during assembly with at least a 2-part side protection (guardrail and intermediate rail).

Caution: There is a risk of falls during assembly of the further scaffolding levels. Measures resulting from the risk analysis performed by the scaffolding erector must be taken, e.g. use of the Layher AGS.

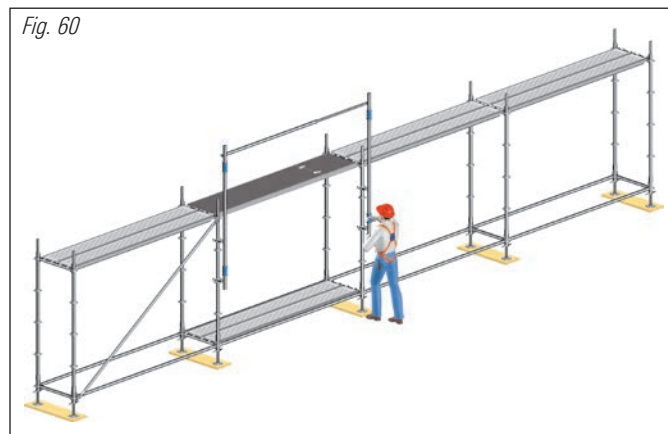
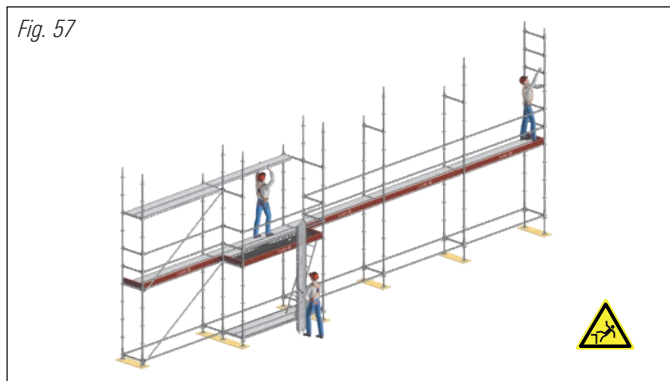
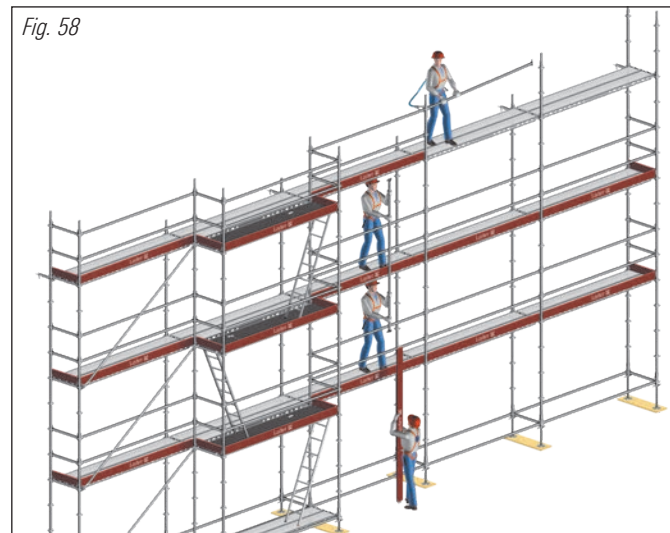

Fig. 57



10. On the next level, fit vertical standards. The measures from the risk assessment and the requirements of the assembly instructions must be complied with here.
11. Fit three-part side protection, comprising handrail, intermediate rail and toe board. The measures from the risk assessment and the requirements of the assembly instructions must be complied with here.
12. Attach vertical diagonal braces. Diagonal braces should be fitted preferably on the outside of the scaffolding (see section 4 and technical brochure).
13. Insert the access deck and steel decks, then close the lift-off preventer. Knock in the wedges.
14. **Caution:** Attach the necessary wall ties continually as scaffolding assembly progresses. See the section on Anchoring.
15. **Caution:** Keep the hatches in access decks closed at all times! Only open them when needed, and close them again immediately afterwards! When temporary boards are used, they may be on top of the access hatch. In this case the access hatch cannot be opened.

Fig. 58



16. **Caution:** Complete the top working level with three-part side protection at the edges at risk from falls.

Fig. 59

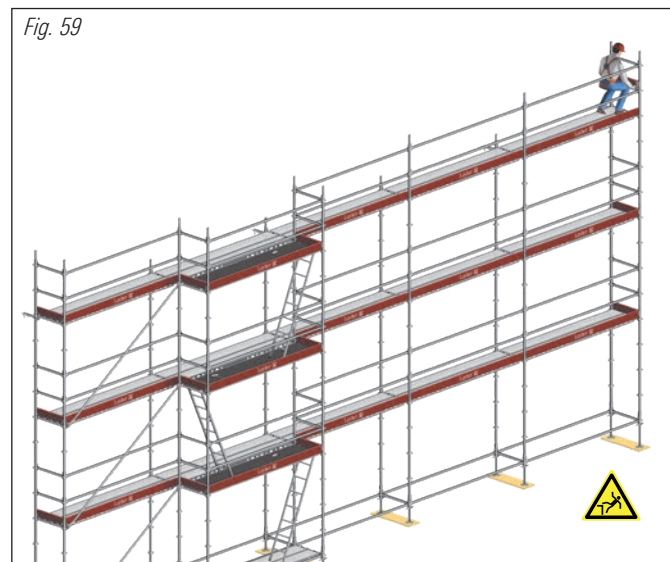

5.2 Diagonal bracing

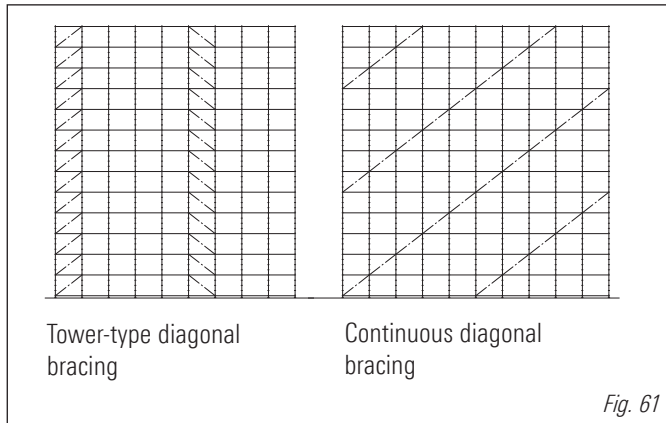

WARNING

Absent diagonal braces and/or horizontal ledgers reduce the stability of the scaffolding structure and can lead to its collapse.

High vertical loads can make it necessary to install additional ledgers and vertical diagonal braces (see technical brochure).

6. TOWER SCAFFOLDING

Tower scaffolding is used extensively for inspection work in industrial plant and shipyards etc., as mobile towers (supplemented by Layher rolling tower wheels, see section 11 on "Mobile Scaffolding Units"), as the basis for birdcage scaffolding, or for dissipating vertical loads as support scaffolding (supplemented by Layher head jacks). The automatic rectangularity of Layher Allround equipment permits rapid and hence economical assembly and dismantling of this frequently used scaffolding type.

Caution: Check the surface for sufficient load-bearing capacity and lay out suitable load-distributing bases.

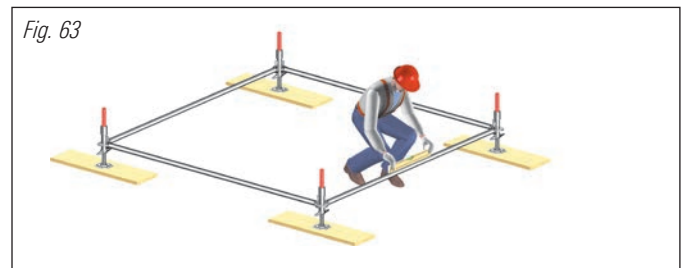
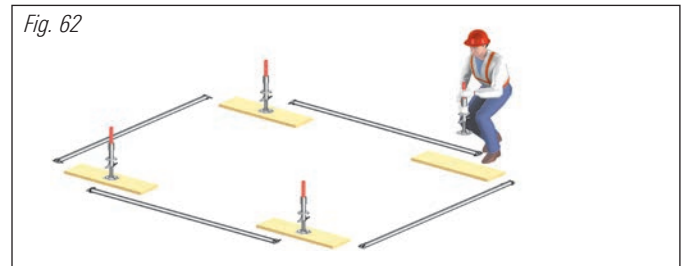

1. Lay out ledgers and place load-distributing bases at the corners.
2. Position adjustable base plates with attached base collars on load-distributing bases.
3. Connect ledgers in the small holes of the rosettes, and align the base frame of the tower scaffolding using a spirit level.

Fig. 64

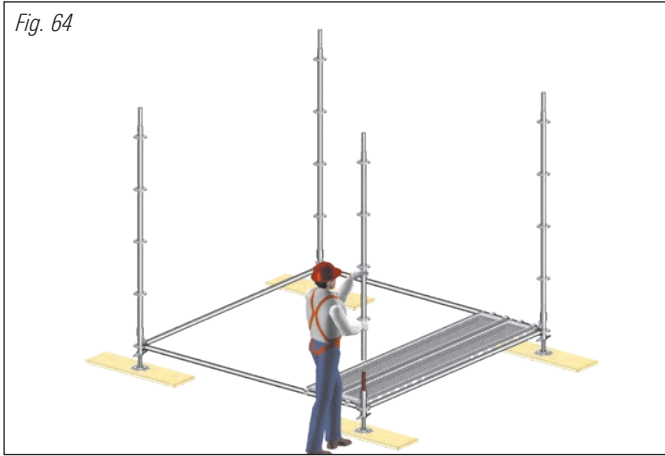

4. Insert decks in the access area. These can be advantageous for right-angled alignment of the basic structure.
5. Fit vertical standards.
6. Fit ledgers.

Fig. 65

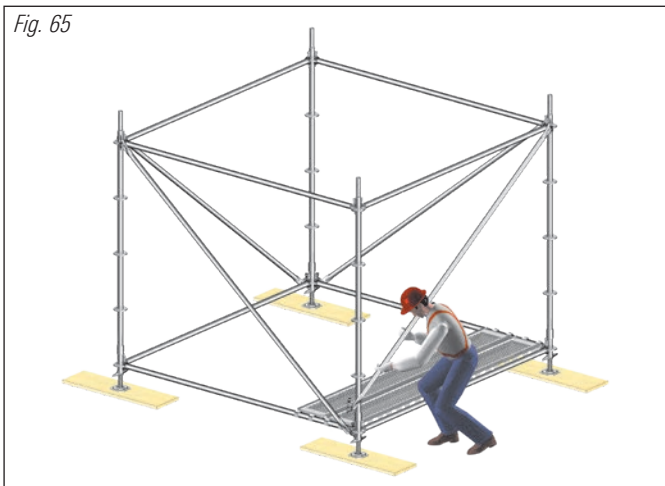

7. Stiffen all 4 sides of the scaffolding using vertical diagonal braces. Install decks. Diagonal braces should be fitted preferably on the outside of the scaffolding. Absent diagonal braces reduce the stability of the scaffolding (see section 4).
8. Knock in wedges.

Fig. 66

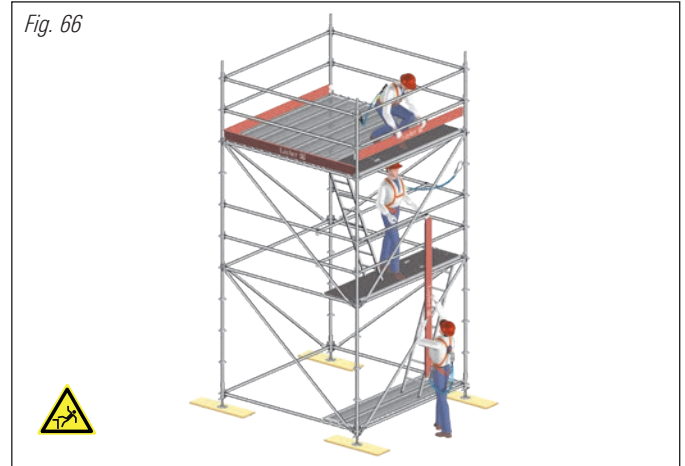

9. The further scaffolding levels must be assembled taking into account the risk assessment of the scaffolding erector. The instructions regarding temporary boards in section 4 must also be followed here.
10. Knock in wedges.
11. Install vertical diagonal braces on all 4 sides of the intermediate level. Diagonal braces should be fitted preferably on the outside of the scaffolding.
12. Attach support ledgers as side protection on the inside of the access deck in the intermediate level. Knock in the wedge to prevent the support ledger from shifting!
13. On the working level, install the three-part side protection all the way round. The stability of the tower scaffolding must be verified in each specific case. If necessary, stability must be assured by anchoring, ballasting weights, bracing or widening of the scaffolding.

Caution: During assembly, there may be a risk of falls. Assembly must take into account the results of the risk assessment. If temporary boards are used instead of decks, or if the scaffolding level is not decked over its full surface, sufficient horizontal stiffness must be ensured. The suitability of the support ledgers for vertical load transmission can be verified with the aid of our technical brochure. If some ledgers or diagonal braces cannot be fitted for project-specific reasons, horizontal forces can for example be transmitted via anchors or the frame, possibly with bundled standards (see Fig. 67).

Fig. 67

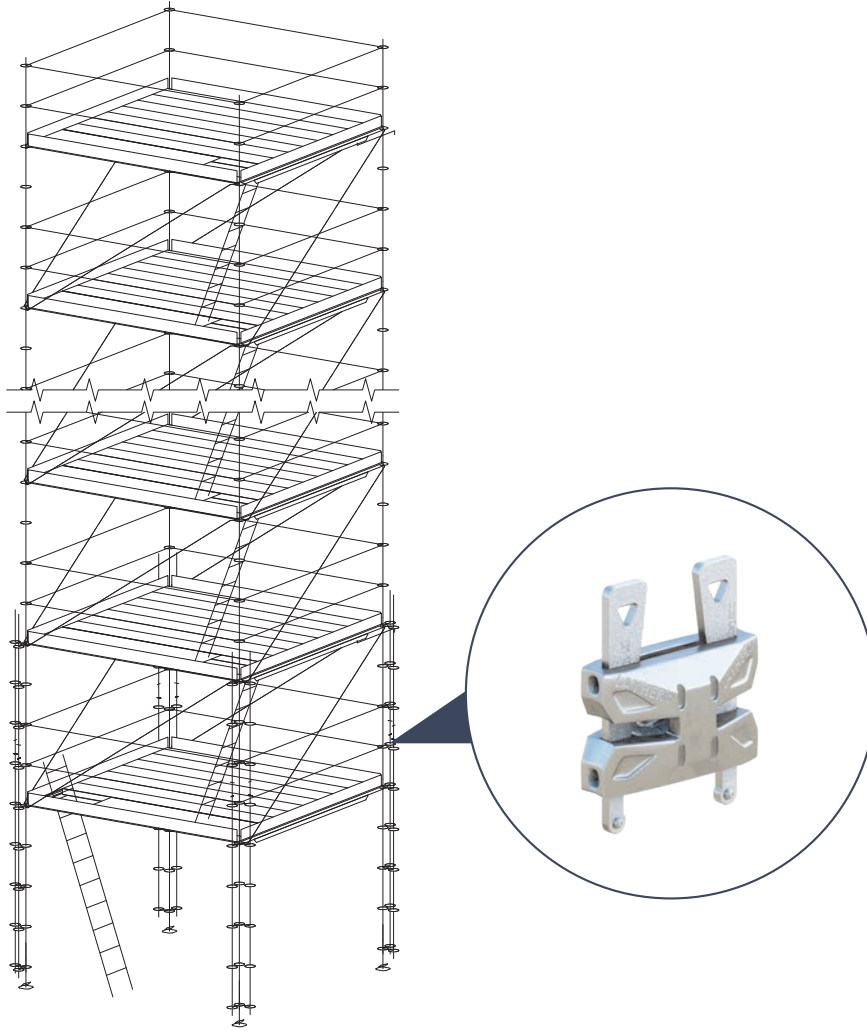

Depending on the assembly height, the standards must be doubled at the tower base using the double wedge head coupler for reinforcement.

7. BIRDCAGE SCAFFOLDING

Birdcage scaffolding can be used to cover ceilings, and is also used as support scaffolding. Assembly is similar to that for tower scaffolding, with particular attention being given to bracing of the scaffolding structure. Check the surface for sufficient load-bearing capacity and lay out suitable load-distributing bases. Information on assembly heights, standard loads etc. can be found in our technical brochure.

Fig. 68

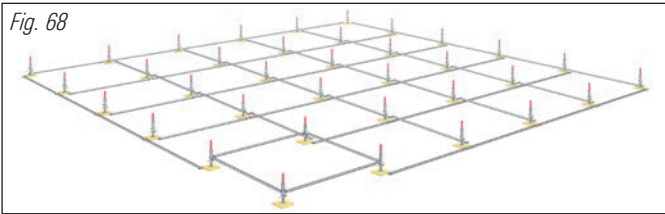

Fig. 69

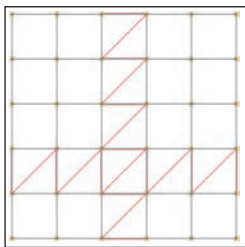
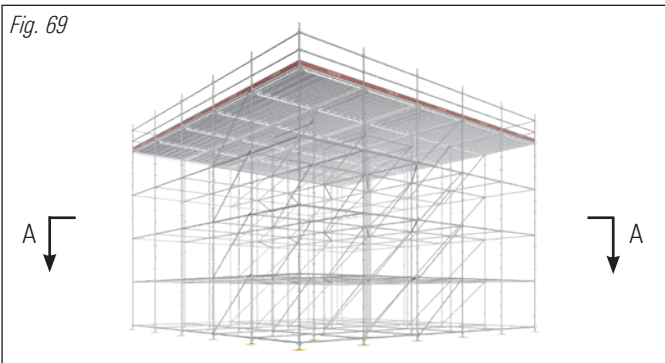

Fig. 70 Section A - A

The vertical diagonal braces must be arranged such that every axis of the birdcage scaffolding is sufficiently braced. To do so, in at least every fifth bay a vertical diagonal brace must be arranged. Non-braced axes must be connected to the adjacent braced axes using horizontal braces or other horizontal sections, such as scaffolding bays laid with scaffolding decks.

Caution: Stiffening in every fifth bay is the minimum required; absorption of greater loads may require a denser arrangement of diagonal braces. Information on diagonal bracing and the resultant load-bearing capacities, plus examples of the design of the top end of the scaffolding, can be found in our user manual or in Fig. 71.

To avoid having protruding spigots on the work level, it is recommended that the upper end of a standard axis be designed with an Allround standard without spigot (2604.xxx). If the decks of the work level are arranged alternating (chequerboard-like, see Fig. 71), the load introduction area of the support ledgers is reduced. This can be structurally sensible in the case of higher load classes and corresponding bay lengths.

Fig. 71

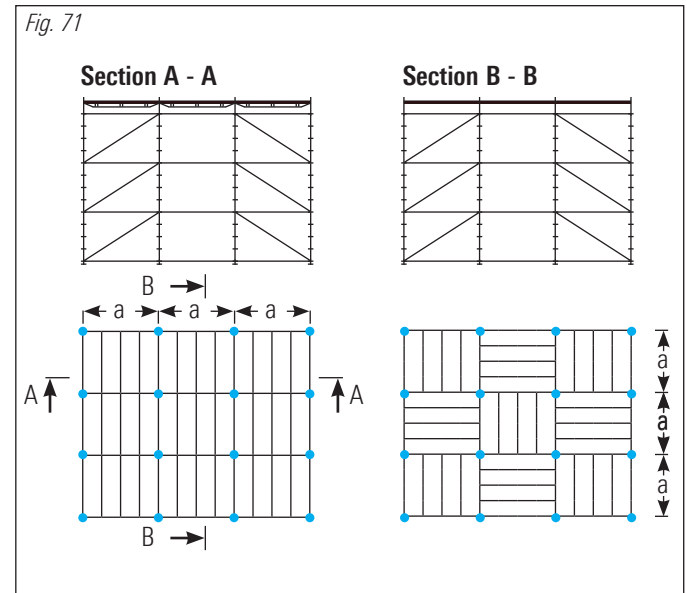

8. SHORING

With Layher Allround, shoring can be put up quickly and economically for the safe transmission of loads.

Caution: The surface must be tested and verified. Suitable load-distributing bases must be laid out for load transmission.

8.1 Shoring, e.g. for concreting of floors

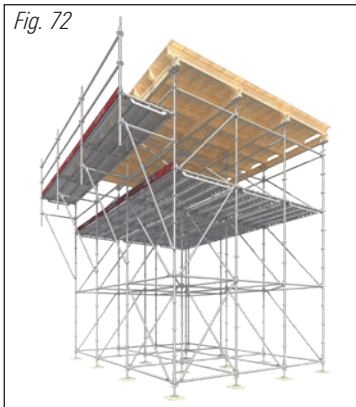

1. Support scaffolding, used for example for concreting of floors, is constructed like tower and birdcage scaffolding.
2. At the top level, use vertical standards without spigots.
3. Fit head jacks onto the vertical standards.

Caution: The load-bearing capacity for the loads to be transmitted must be verified, with particular attention to stiffening with vertical diagonal braces, the bay width and the spindle extension of the base plates and head jacks. Information on load-bearing capacities can be found in our Allround technical brochure. Diagonal braces should be fitted preferably on the outside of the scaffolding. It must be pointed out that the load level in shoring is considerably higher than in the usual parts of work scaffolding.

Caution: The loads of the formwork supports must pass centrally into the head jacks. This can be achieved for example by turning the head jack all the way until the head jack side contacts the formwork support. In concreting work, very high horizontal forces can occur even at the top. It may be possible to dissipate them in the top area by means of the anchors. The formwork supports must be prevented from tilting.

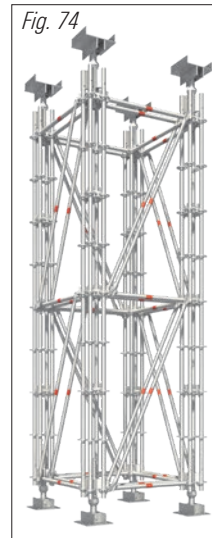

Fig. 73
Equalising plate for adjustable base plates

Base plates with a rigid foot plate can be placed vertically on a surface with a slope of up to 16 percent using the equalising plate for adjustable base plates. The foot plates are in full-surface contact, which is advantageous for structural strength.

The length of the vertical standards must be selected so that the adjustable base plates and head jacks are extended as little as possible, but still permit later removal of the formwork. If bracing of the base plates is necessary, wedge spindle swivel couplers can be used to do so.

8.2 Heavy-duty tower



Heavy-duty tower for dissipation of high individual loads, made from Allround standard material using the following additional parts:

- Head jack for heavy-duty tower
- Heavy-duty 4-way end piece
- Wedge head coupler, double
- Heavy-duty 4-way base collar
- Foot for heavy-duty tower

Fig. 75

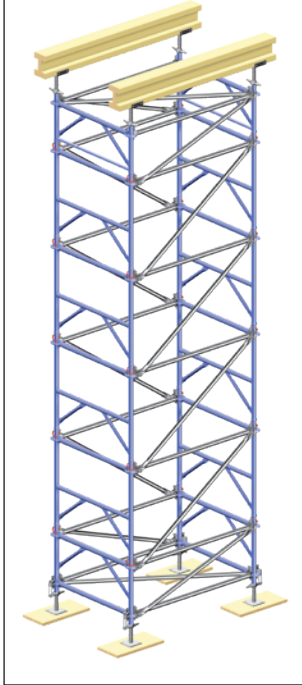

To construct shoring quickly and efficiently, we recommend the use of the Allround Shoring Tower TG 60. See separate instructions for assembly and use of Allround Shoring Tower TG 60.

9. CIRCULAR SCAFFOLDING

Thanks to eight possible connections and variable angle selection, curved wall surfaces can be enclosed with scaffolding without any problem. The following distinction is useful here:

Low diameter (up to approx. 5 m) = rectangular scaffolding enclosure supplemented with Layher steel planks.

Large diameter = Use of the variable angle selection during connection to the Allround rosette.

Check the surface for sufficient load-bearing capacity and lay out suitable load-distributing bases.

Enclosing structures with low diameter

Fig. 76

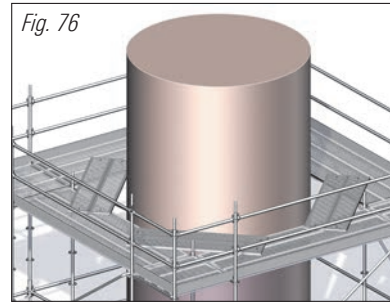
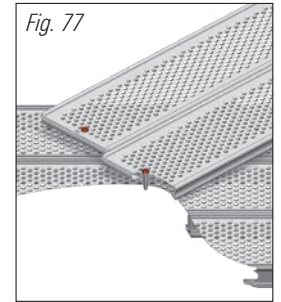

Fig. 77



1. Lay steel planks at the inside corners.
2. The overlap length of the steel planks when secured with at least one locking screw per support should be at least 10 cm. The locking screw is screwed into two congruent holes in the steel deck and the steel plank.

A further option with small diameters is the use of interchangeable ledgers or special corner decks as shown in the figures below.

Fig. 78

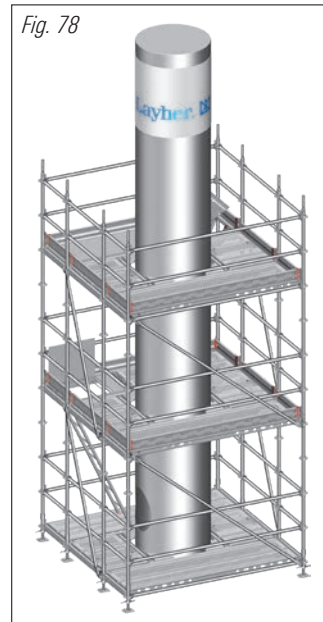

Fig. 79



Fig. 80

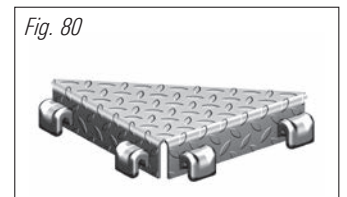
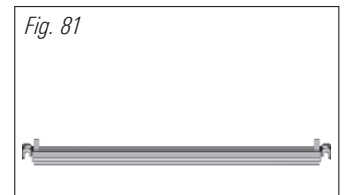
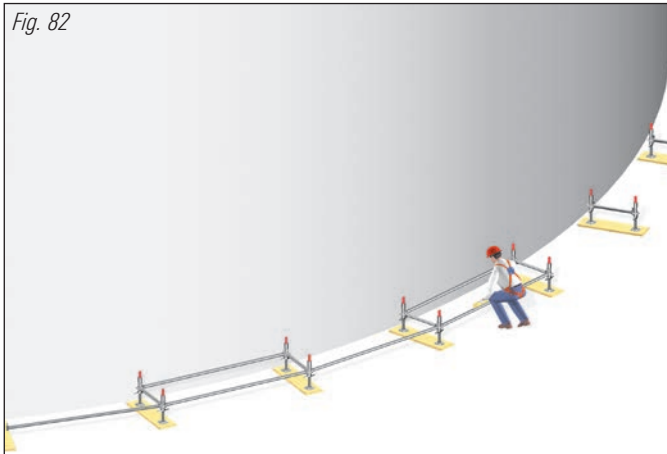

Fig. 81



Scaffolding round an oil tank with large diameter



1. Lay the ledgers to match the curvature of the round tank.
2. Lay out load-distributing bases, position adjustable base plates with attached base collars.
3. Align the basic frame of the scaffolding with the tank and level it using a spirit level.

Caution: When positioning, keep within the maximum wall clearance, otherwise there is a risk of falls on the wall side.

Tip: Depending on the radius, it is an advantage to insert all ledgers into the large holes (solution 1) or only the ledgers of the intermediate bays (solution 2).

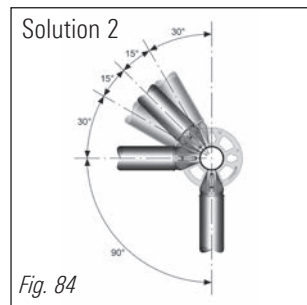
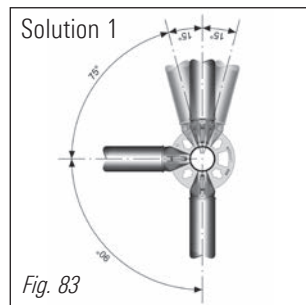

When the large rosette holes are used, rectangularity in the basic structure is no longer predetermined. In this case, it is recommended that in all rectangular main bays – not only in the access bays – decks are already installed in the basic structure. If it is not possible to fit any system ledgers into the fitted bays on the inside and outside, e.g. for geometrical reasons, all main bays must be braced using vertical diagonal braces and possibly section braces. The structurally useful ring effect of the system ledgers completely spanning the circumferential direction does not apply here.

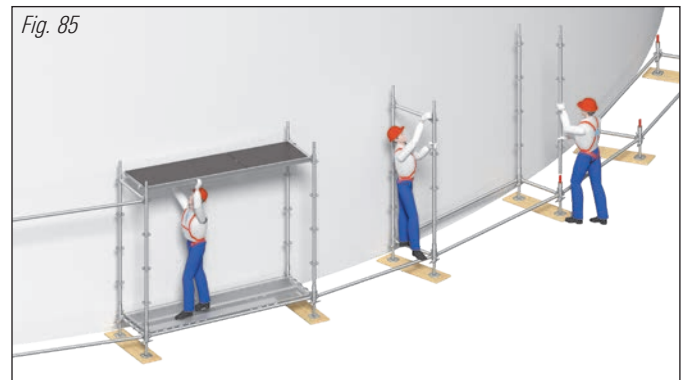

4. Fit vertical standards.
5. Insert decks in the access bay as a support surface for the ladders.
6. Fit transoms.
7. Insert access deck. Cover and ladder must be snapped in place during transport.

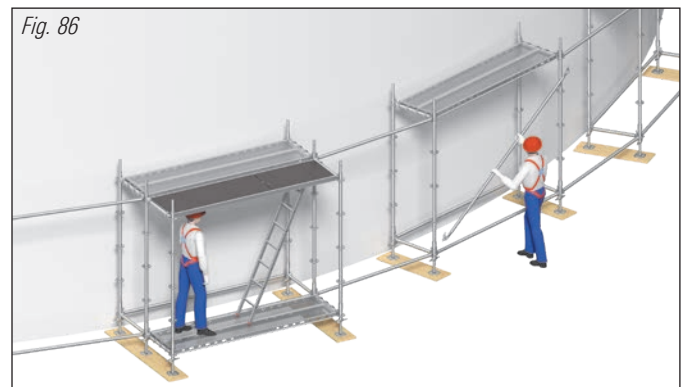

8. Insert decks in the rectangular main bays, close the lift-off preventer.
9. Stiffen at least every fifth bay with vertical diagonal braces. Vertical diagonal braces should be fitted preferably on the outside of the scaffolding.
10. Fit ledgers of intermediate bays.
11. Knock in all wedges.
12. Lay steel planks in the intermediate bays, not exceeding their permissible span. If the minimum guardrail height is not attained, a third ledger at the 1.50 m level is required.

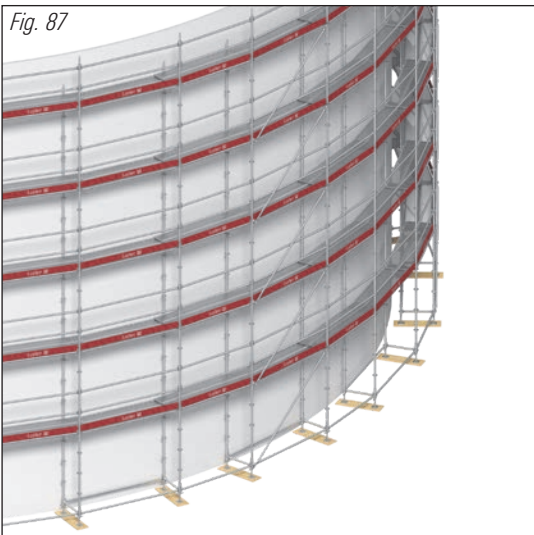

13. Repeat the assembly steps until the required height has been reached.

Caution: Anchors and/or pressure supports must be installed continually as scaffolding assembly progresses. In the area of the intermediate bays, gaps can occur when planks are used for bridging. This must be taken into account during planning. It can also lead to collisions of the planks with the toe boards. When access decks are used, we recommend the use of an access deck with side-opening hatch (3858.xxx) that allows laying of the planks in front of the hatch.

Instead of ladders, external staintowers can be used for access.

10. SUSPENDED SCAFFOLDING

To minimise the amount of material used for scaffolding at great heights, or when the surface is not sufficiently firm, work surfaces can be created with suspended scaffolding structures.

Suspended scaffolding is used in many different versions, so the following assembly sequence is intended as an example.

Suspended scaffolding can be suspended in a variety of ways. Suspension from ceilings or other structural components is possible using wall-plugs, suspended scaffolding couplers, clamping couplers, girder grippers or chains. The introduction and transmission of suspension forces from the suspended scaffolding into the structure must be separately verified.

Caution: For suspended scaffolding, either vertical standards with bolted spigot or LW standards with integrally cast spigot must be used so that the expected tensile forces can be dependably transmitted (see section 4.4 too in this connection).

The pull-resistant design of the standard joint is achieved as per section 4.4 for the respective tensile force. The need for firm tightening of the nuts is also repeated here (see page 17).

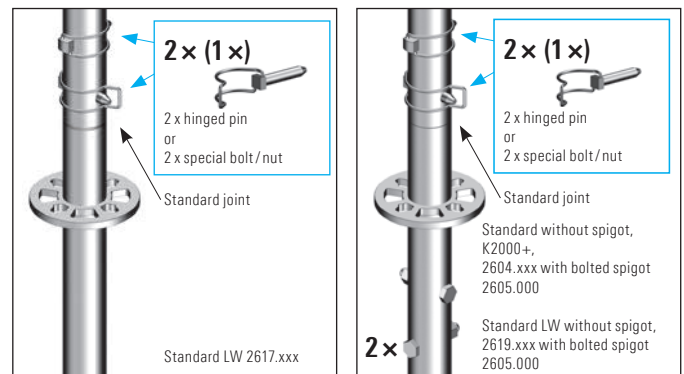
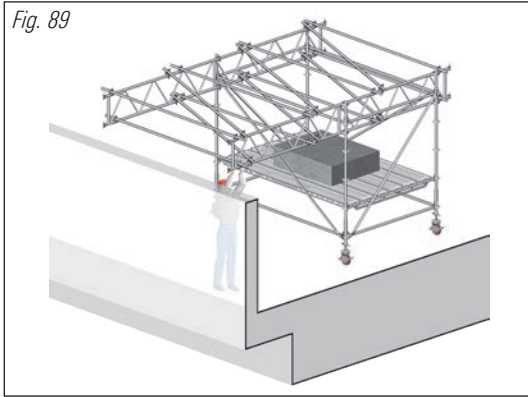

Fig. 88a: Tensile joint with LW standard Fig. 88b: Tensile joint with bolted spigot

Fig. 89



1. Assemble the ballasted tower scaffolding (Fig. 89).

The necessary ballast must be ascertained by a structural strength calculation. Safety measures must be taken in accordance with local regulations. Only solid materials may be used as ballast.

2. Connect the lattice beams to the tower scaffolding and brace them with tubes and couplers according to structural strength requirements.
3. Push the tower scaffolding up to the edge so that the ends of the lattice beams extend beyond it.

Fig. 90

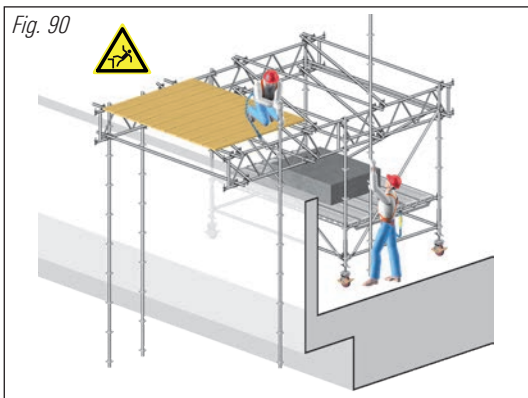

4. Lay temporary boards, complying with their maximum span.

WARNING

When assembling suspended scaffolding, there may be a risk of falls. Perform this work step only with an approved fall protection system, if the latter has been specified in the risk assessment as an adequate means for protection against falls.

Keep the hatches in access decks closed at all times! Only open them when needed, and close them again immediately afterwards!

5. Use a Layher double coupler to connect vertical standards to the upper and lower chords of the lattice beam with the specified spacing (if necessary using a transom as an assembly aid). Secure the double couplers with forward-mounted couplers.

Tip: Install the vertical standards upside down, this makes later connection of further suspended vertical standards easier.

Fig. 91

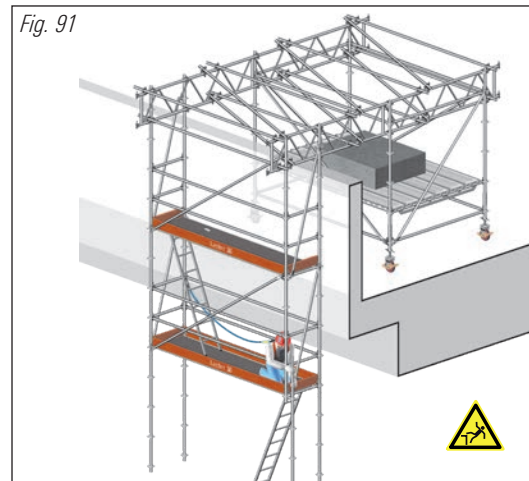

6. Go to the level underneath.
7. Fit horizontal ledgers and insert decks.
8. Install the three-part side protection.
9. Fit vertical diagonal braces on three sides. Diagonal braces should be fitted preferably on the outside of the scaffolding. Defects in diagonal bracing lead to a reduction in load-bearing capacity.

10. Insert vertical standards with bolted spigot, and connect them with 2 special bolts M12-8.8 and nuts or with 2 hinged pins per spigot end. Repeat the working steps until the necessary depth has been obtained.

Fig. 92

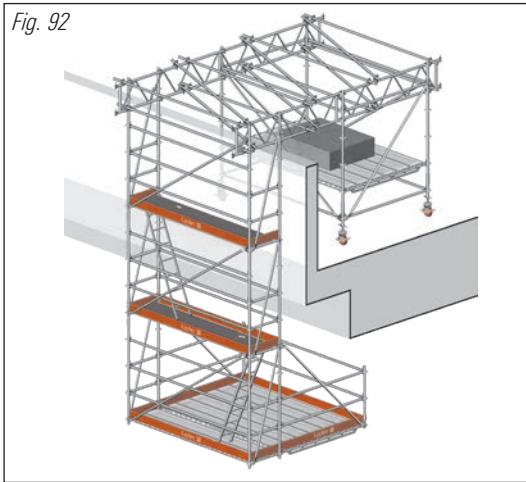

11. Assemble the projecting part as described in the section on brackets and cantilevers.
12. Install the three-part side protection.

Tip: Alternatively to the assembly sequences shown, individual segments, e.g. the suspended part, can be preassembled on the ground and then attached to the projecting part using a crane. This reduces the risk of falls. The work must be performed so that the time spent in activities where there is a risk of falling is as short as possible.

11. MOBILE SCAFFOLDING UNITS

The use of mobile scaffolding units allows work on large areas with a small amount of material. Mobile scaffolding units can be provided with wheels to make them into rolling towers, or designed as crane-movable units.

11.1 Rolling towers

Caution: No personnel or loose objects may be on rolling towers when these are being moved. Rolling towers may only be moved by exerting force on their base, never on the upper part of the structure. The wheels of the mobile tower must always be locked unless the tower is being moved. Mobile towers may only be moved over flat surfaces.

Fig. 93

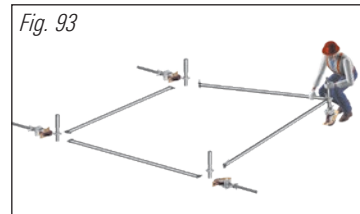

1. Lay the ledgers at right angles to one another, and lay the extended base collars at the ends.
2. Place wheels at the ends.

Caution: The wheels must be locked when the rolling tower is being assembled.

3. Connect the two first ledgers in the small holes of the base collar and insert the wheel.
4. Connect in sequence the base collars, wheels and ledgers, but do not knock in the wedges. In rolling towers, in particular those made from components of the Allround Aluminium modular system, use of the extended base collar (2660.000) at the base area is recommended.
5. Align the foot/base of the rolling tower using a spirit level. (Cf. section 6 on tower scaffolding)
6. Install steel decks in the access area and secure them against lifting out. Knock in the wedges.
7. Place standards on the vertical base collars.
8. Further assembly is analogous to that of scaffolding towers.

11.2 Crane-movable units

If scaffolding is not assembled at its final intended location, or has to be repositioned after use, or if the work process requires section-by-section preassembly and joining together of smaller units, scaffolding can be moved by crane if it has been designed accordingly. Suitable fastening gear and crane suspension devices must be used for crane movement. Suitable crane suspension devices and fastening gear can include:

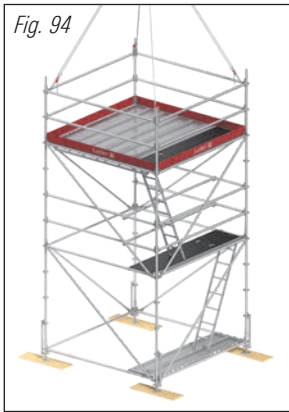

- Sling underneath a braced rosette
- Hook directly at the rosette
- Crane eyelet connector (4724.xxx)
- Fastening gear for crane movement (2630.000)



Caution: During repositioning, exceptional stresses can act on the scaffolding units being moved. These must be calculated in advance and their effects assessed. Lifting and moving using a crane must take place under the supervision of a qualified person. Base plate must be secured against falling out (Fig. 95).

WARNING

The joints of the vertical standards must be firmly connected to one another. It must be verified whether vertical standards with bolted spigot or standards with press-in spigot and locking pins are used. Allround standards with press-in spigot are suitable for transmitting only planned low tensile forces on standards.



Fig. 95: Base plate fastening with wedge head



Fig. 96: Connection of vertical standards with bolted spigot

Caution: The stability of the mobile scaffolding unit must be verified in each specific case. If necessary, stability must be assured by anchoring, ballasting, bracing or widening of the scaffolding.

12. ANCHORING

Caution: Anchoring is essential for the stability of the scaffolding and must be continually installed as scaffolding assembly progresses.

Scaffolding may only be anchored on components with sufficient load-bearing capacity; if necessary, the anchoring surface must undergo pull-out tests. A check can be dispensed with if sufficient load-bearing capacity can be assessed on the basis of professional experience and the characteristic value of the anchoring force A_{Lk} does not exceed 1.5 kN, and in the case of reinforced concrete as per DIN 1045 as the anchoring surface does not exceed 6.0 kN. The load-bearing capacity of all fastening devices (anchors, ring screws, wall plugs) for the anchoring forces must be verified. It must be ensured here that ring screws projecting far out of the anchoring surface can transmit mainly axial forces and only very low lateral forces. Ring screws must always be screwed into the plugs over the full length.

WARNING

Absent or insufficiently strong anchoring reduces the stability of the scaffolding structure and can lead to its collapse. Anchoring may only be installed and removed by the scaffolding erector.

The scaffolding can be anchored using the following aids:

Anchoring with wall plug and ring screw in walls

- Allround wall tie
- Short wall tie, with 1 double coupler on the inner standard
- V-type tie with wall ties
- Long wall tie, with 2 double couplers on 2 standards
- O-ledger with 2 double couplers

Anchoring on support structures using clamping couplers and tube/coupler structures

- Anchoring on vertical components
- Anchoring on horizontal components

Allround wall ties only in conjunction with U-sections

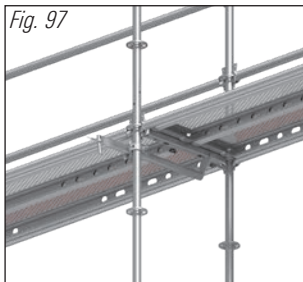

1. Connect Allround wall tie with double coupler to standard, inserting the wall tie into the ring screw.
2. The rear end of the Allround wall tie must enclose the U-section.

Short wall tie, with one double coupler

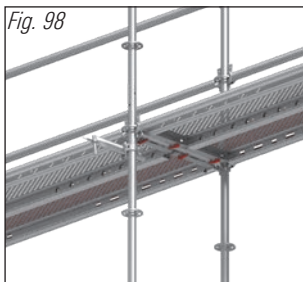

1. Connect short wall tie with double coupler to the inner standard, inserting the wall tie into the ring screw. This type of anchoring can only transmit very low forces parallel to the facade.

V-type tie

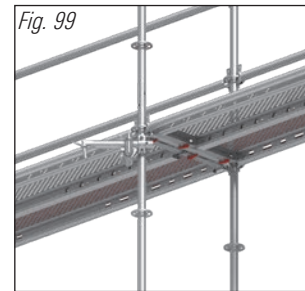

1. Connect wall tie with double coupler to standard, inserting the wall tie into the ring screw.
2. Fasten second wall tie with double coupler to first wall tie, inserting the wall tie into the ring screw.
3. Alternatively: connect both wall ties to the standard.

Long wall tie (up to 1.75 m) with 2 double couplers

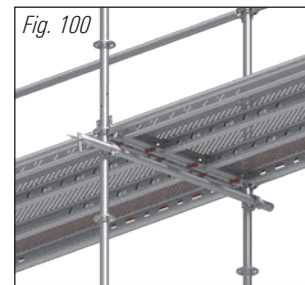

1. Connect wall ties with 2 double couplers to both standards, inserting the wall tie into the ring screw.

O-ledger with 2 double couplers

With very wide scaffolding structures, it may be necessary to make the anchoring with the aid of an O-ledger.



1. Connect O-ledger to both standards using double couplers, slide wedge head over the ring screw.
2. Push the wedge through the ring screw and secure it by a hammer blow.

Anchoring on vertical components

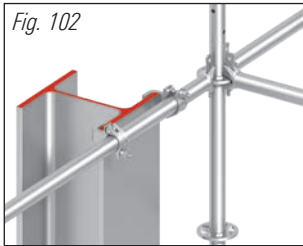

Anchoring on steel supports with the aid of clamping couplers.

1. Attach clamping couplers lightly to the scaffolding tube, then slide them up to the flange of the support.
2. Couplers must firmly enclose the flange.
3. Tighten the couplers.

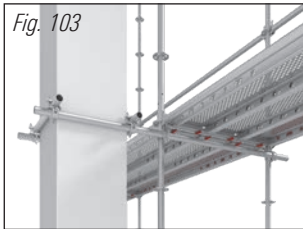

Anchoring on concrete supports or jacketed supports by tube/coupler structure. Tighten all couplers.

Anchoring on horizontal components

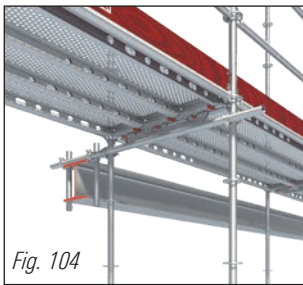

Anchoring on horizontal beams with tube/coupler structure, in the case of steel beams with the aid of clamping couplers. Assembly sequences corresponding to those for anchoring on steel or concrete supports.

Anchoring using the ETICS tie

Using the Layher ETICS tie, relatively high parallel forces and forces vertical to the facade can be transmitted into the ground in comparison with ring screws. It is used for both facade and industrial scaffolding (for more details see the instructions for assembly and use of the ETICS tie).

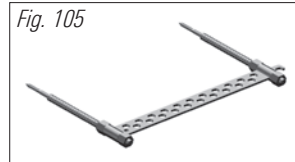

The anchorings shown differ in their force absorption and are not interchangeable without a structural strength verification! Wall ties and other tube and coupler anchors must be attached directly adjacent to the braced rosettes. In the case of anchoring outside braced connectors, the load transmission inside the scaffolding must be verified. If ties project into the deck surface, there is a risk of injury.

Anchoring configuration

The selection of the anchoring configuration depends on the bay width, the load on the scaffolding and its design, live load, wind load and the structural height of the scaffolding. The anchoring configuration must be selected with due consideration of these factors. Three typical anchoring configurations are shown here as examples.

As the load on the scaffolding increases, the anchoring configuration must become denser in order to pass the forces safely into the anchoring surface. The denser the anchoring configuration with the same effect, the lower the individual tie forces.

Anchoring is particularly important if the scaffolding is covered with nets or tarpaulins. Subsequent covering requires additional anchoring.

Fig. 106: anchoring configuration 8 m, vertically offset by 4 m. Anchor standards at the end of the scaffolding every 4 m. Anchor the remaining standards as shown. Vertical tie spacings should be 8 m, with an offset by 4 m in adjacent axes.

Fig. 107: Anchoring configuration every 4 m. Anchor the standards vertically every 2 m.

Fig. 108: Anchoring configuration every 2 m. Anchor the standards vertically every 2 m. Dense anchoring configuration for high wind loads (e.g. tarpaulin covering).

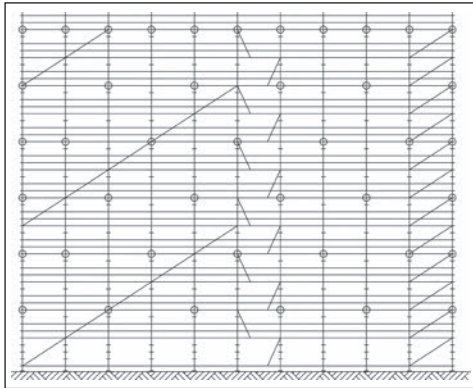

Fig. 106: Anchoring configuration 8 m, vertically offset by 4 m

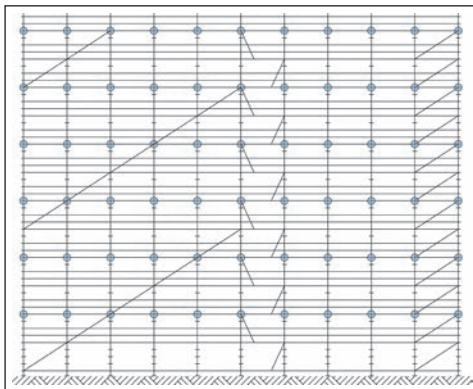

Fig. 107: Anchoring configuration 4 m

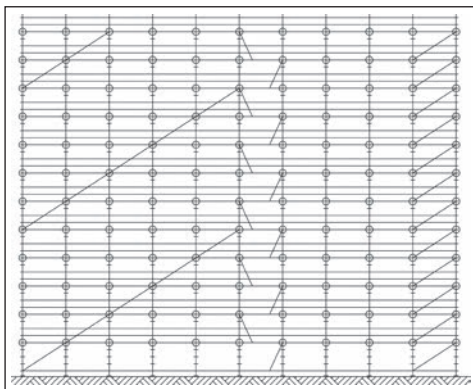

Fig. 108: Anchoring configuration 2 m

13. ACCESSES

For convenient access inside the scaffolding, Layher recommends a platform stair, in particular when

- material is to be transported via this access,
- the height of the access exceeds 5 m or
- extensive work is to be performed from the scaffolding itself.

Platform stair access in facade scaffolding

1. An additional outer bay is fitted to the scaffolding, as described in section 5.
2. Lay the platform stair over the transoms, and close the lift-off preventer.



Fig. 109

3. At the entry to the platform stair, fit two stair guardrail adapters to the rosettes on the outer standard.
 4. Attach standards and then fit ledgers.
 5. Place the stair guardrail at the top over the ledgers and at the bottom over the stair guardrail adapters.
 6. Fit stair guardrail.
 7. Assemble second scaffolding level, see section 5.
 8. Fit next platform stair – see item 2.
 9. At the exit from the platform stair, connect two stair guardrail adapters to the rosettes on the outer standard.
 10. Install stair guardrail posts (2638.400).
 11. Install O-ledger with wedge head and half-coupler (2638.401/402) for walkway safety.
 12. Fit the three-part side protection.
- Steps 3, 5 and 9 are not needed if Allround stair guardrails with

swivelling wedge heads are used.

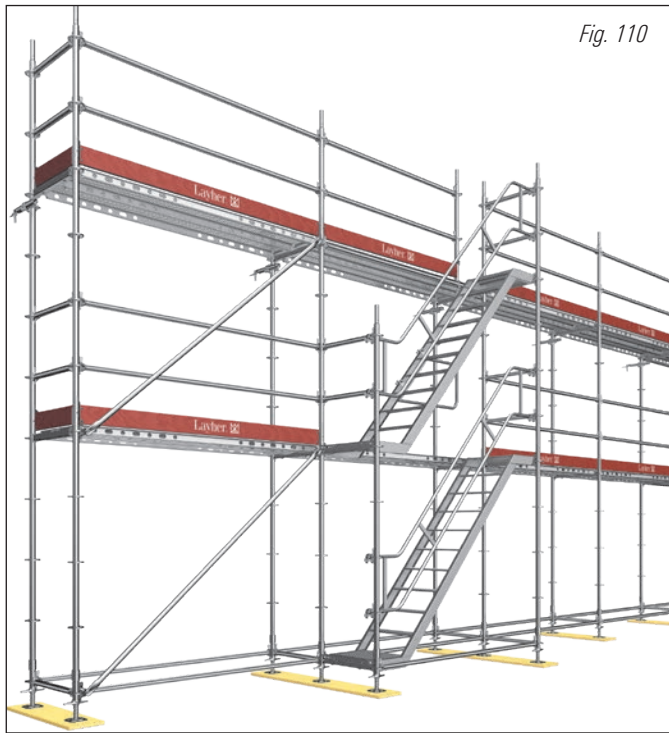

If other measures are used for extending the top level, ensure that the guardrails are a perfect fit and resistant to horizontal loads. Depending on the design, gaps can occur between the deck and the stair. These must be closed as indicated in the present assembly instructions, for example by gap ledgers, gap covers, telescoping gap decks etc. to avoid any tripping hazards. Depending on local requirements, it may also be necessary to install a continuous stair guardrail (1752.xxx) and an internal guardrail (1752.xxx). When installing diagonal braces, there is a risk of crushing between the diagonal brace and the guardrail.

Platform stairtower, free-standing

Check the surface for sufficient load-bearing capacity and lay out suitable load-distributing bases.

1. Assembly is as for the platform stair access in the facade scaffolding, but with 4 standards.
2. The minimum width of the platform stairtower is 1.40 m.
3. At the exit, fit two stair guardrail adapters to the standard at the rosettes.
4. Place the stair guardrail at the top over the ledgers and at the bottom over the stair guardrail adapters, then knock in the wedges. Alternatively, fit the stair guardrail with swivelling wedge heads.
5. Fit O-ledgers as guardrail and intermediate rail.
6. Fit a support ledger in the middle on the upper longitudinal ledgers.

Attach the necessary anchorings continually in accordance with structural strength requirements, see the section on Anchoring in this respect.

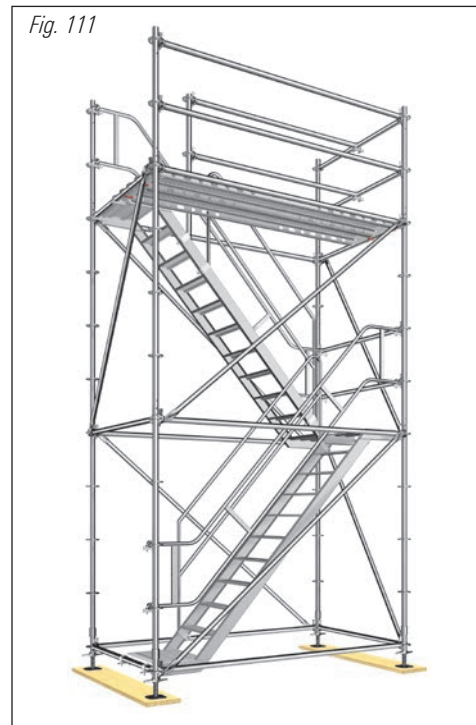

If other measures are used for extending the top level, ensure that the guardrails are a perfect fit and resistant to horizontal loads. Depending on the design, gaps can occur between the deck and the stair. These must be closed as indicated in the present assembly instructions, for example by gap ledgers, gap covers, telescoping gap decks etc. to avoid any tripping hazards. Depending on local requirements, it may also be necessary to install a continuous stair guardrail (1752.xxx) and an internal guardrail (1752.xxx). When installing diagonal braces, or during later use of the scaffolding, there is a risk of crushing between the diagonal brace and the guardrail.

Internal access/ladder access – use of access decks



Internal ladder access with access decks. Arrange hatch openings off-set.

Caution: Keep hatches in access deck closed when not in use.

This also applies for transporting the access decks. At the bottom level of the access bay, scaffolding decks must be installed as a ladder support surface.



Caution: If access decks without integrated ladder are used, the ladder must be secured against slipping. The ladder must be installed in such a way that the access hatch can be closed to prevent any tripping hazards. If the ladder mounting collides with the toe board, the access deck must be installed in an inner bay without a toe board at its end, or T15 ladders must be used.

Internal access/ladder access – bay shortening using support ledgers



Fig. 114

1. Fit longitudinal ledgers on the inside and outside of the access bay at the deck level.
2. Install support ledgers transverse to the longitudinal ledgers.
3. Insert steel decks – 50 cm shorter than the bay length – and close the lift-off preventer.
4. Attach access ladder. Secure the ladder against inadvertent detachment.

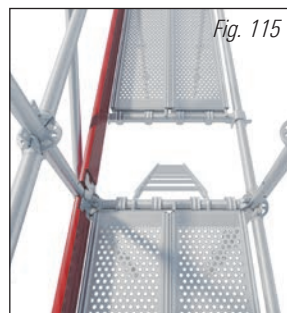

Fig. 115

Local regulations must be checked as to whether the opening has to be closed during working. The access deck 1.00 m (3851.100) can be used for this purpose. This is particularly the case when using access decks is not possible – for example with 2.07 m bays.

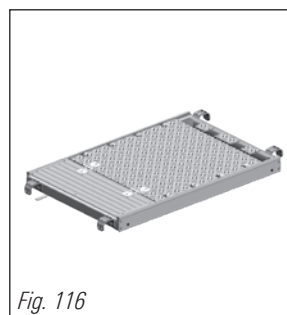

Fig. 116

External access

1. At the level of the exit, fit one O-longitudinal ledger each at the deck level and at 50 cm underneath on the access side.
2. Attach the offset guardrail standard (2606.170) over the previously fitted O-longitudinal ledger and connect it with O-ledgers to the vertical standard.
3. Fit the toe board and secure it using a half-coupler with toe board pins to the offset guardrail standard. If a bolted spigot (4706.xxx) with fitted standard is used as the guardrail post instead of the offset standard, this standard must be secured against turning, for example by installing a diagonal brace.
4. Fit swing door. It must be ensured here that the pin of the swing door is connected in the outer large hole of the rosette so that the door closes by itself. The door always opens inwards into the scaffolding.
5. Fit the tube on the transom using two swivel couplers.
6. Connect access ladder to the tube using two double couplers. In addition, fasten the ladder to the scaffolding with a swivelling coupler too.



Local regulations must be checked as to whether an external access is permitted. If that is the case, the requirements in local regulations relating to maximum access height and to the ladder projection must be complied with. Usually a ladder projection of 1 m is required. It must be ensured that a simple ladder (1004.xxx, 1002.xxx) is used, the stiles of which are suitable for coupler connection. When other ladders are used, sufficient fastening to the scaffolding must be ensured.

Stairtower 500

Check the surface for sufficient load-bearing capacity and lay out suitable load-distributing bases.

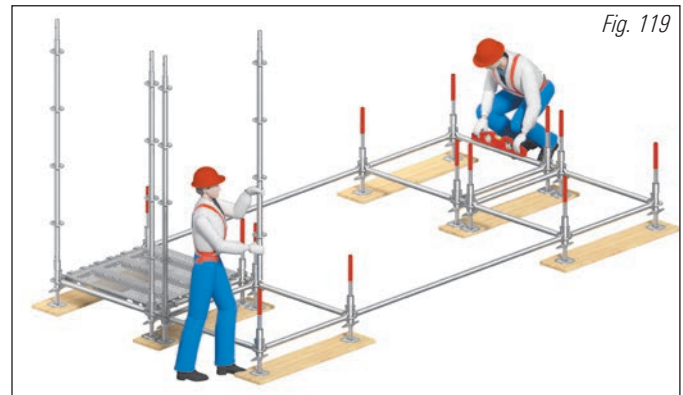
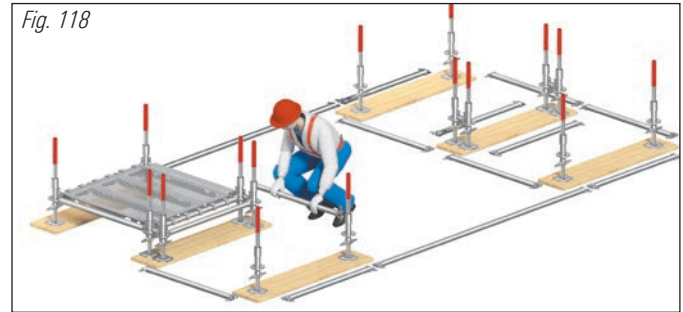

1. Lay out longitudinal ledgers and transoms, double wedge head coupler – incl. temporary assembly ledger of 2.57 m.
2. Place the load-distributing bases.
3. Position adjustable base plates with attached base collars on the load-distributing bases.
4. Connect ledgers in the small holes of the rosettes, and align the base frame of the stairtower using a spirit level.
5. Fit double wedge head coupler.
6. Lay steel decks in the entry bay, and close the lift-off preventer.
7. Fit vertical standards onto the base collars.

Fig. 120



8. Fit ledgers.
9. At the stair entry and exit, fit a ledger with gap cover instead of the normal ledger (to prevent risk of tripping).
10. Remove the 2.57 m long ledgers and fit the stair stringers.

Fig. 121

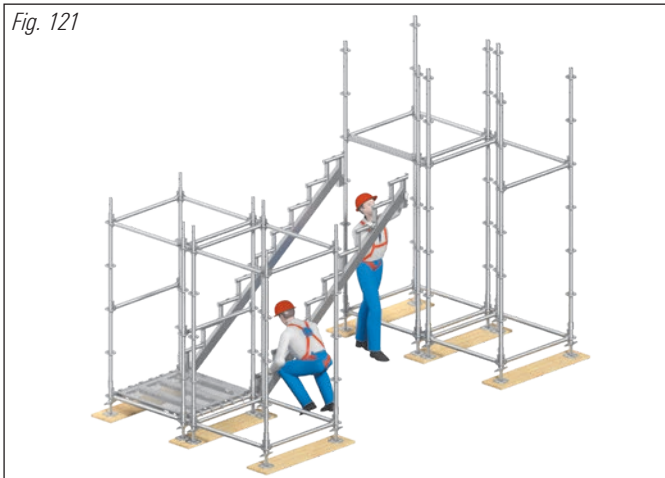

Fig. 122



11. Lay the steel decks, starting from the bottom, on the stringers and ledgers, then close the lift-off preventer. Assembly must take into account the results of the risk assessment made by the scaffolding erector.
12. Install vertical diagonal braces. The diagonal braces should be fitted preferably on the outside of the scaffolding.
13. Fit stair guardrail. To do so, first insert the upper pin into the rosette and then swing the guardrail from the outside towards the inside.

Fig. 123



Fig. 124: Double wedge head coupler



Fig. 125: Gap cover

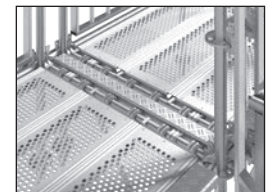

14. Lay the gap cover on the ledgers and close the lift-off preventer.
15. Fit the double wedge head couplers to the second rosette above the steel decks. Knock in the wedges.



16. Repeat the assembly sequence until the required height of the stairtower is reached.

Necessary anchoring and/or ballast weights must be provided in accordance with structural strength requirements, see section on Anchoring in this respect. The load-bearing capacity of the inner standard and of the stair stringer must be verified. In the case of the previously described stairtower 500, a 16-standard variant was selected. Greater assembly heights can be achieved for example with the 32-standard variant; lower assembly heights with the 10 or 12-standard version. The selected standard variant also affects the standard height and the clear headroom. With the 16-standard regular version, the standard height is 2.00 m, resulting in a clear headroom of less than 2.00 m. To attain a larger clear headroom, stairs can for example be arranged in the intermediate bays of the intermediate platforms. Special mention must be made of the horizontal braces that increase the standard loads. Leaving out individual or several components of the horizontal braces reduces the standard loads. Decks must be secured using lift-off preventers.

14. DECK CUTOUTS AND DECK INSERTS

0-support ledger

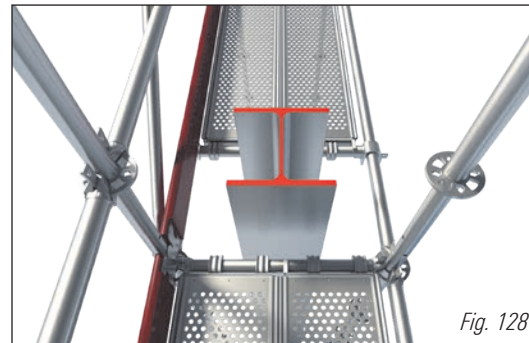

1. Fit longitudinal ledgers on the inside and outside at the deck level.
2. Lay, position and secure the support ledger on the two longitudinal ledgers.
3. Lay steel decks of appropriate length on the support ledgers, then close the lift-off preventer.

O-ledger, steel deck – steel deck

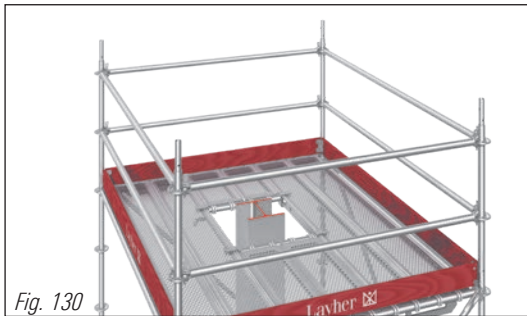

Recesses and accesses are easily constructed using the O-ledger steel deck – steel deck.

1. Swing in the matching support ledger horizontally at the required places above the steel deck sides.
2. Close the securing hooks. Ensure that the securing hooks are not suspended in the vertical position under tension.
3. Insert the steel decks and close the lift-off preventer.

Support ledgers can be used up to max. load class 3. Gaps can occur between the decks on the support ledger and the decks in the main bay. They must be closed where necessary.

WARNING

When steel deck – steel deck O-ledgers or comparable interchangeable ledgers are fitted, it must be ensured that their ends are completely pushed on over the deck sides and that the upper part of the securing hook grips around the steel deck and is locked. Non-locked steel decks can cause a collapse.

15. CORNER SOLUTIONS

Erect the scaffolding starting from the outer corners of the building. Any equalising bays necessary must not be arranged in the corner area. The entire scaffolding width must be maintained round the corners. Further design variants can be found in our Allround technical brochure.

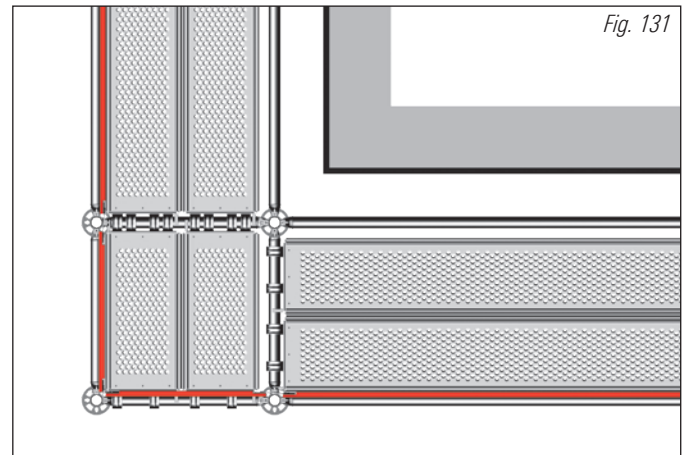

With 4 vertical standards and short decks.

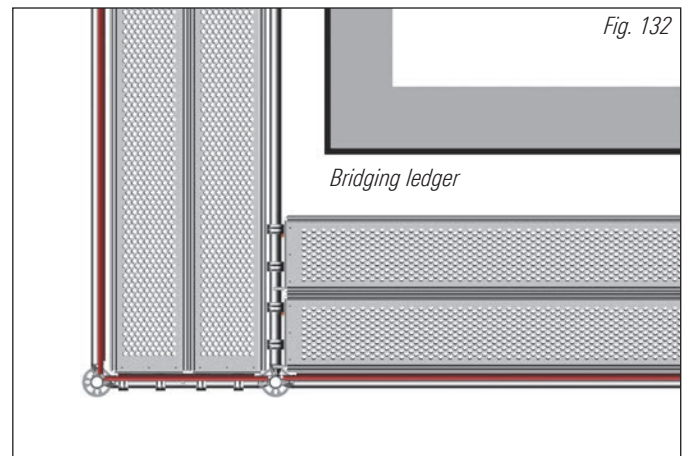

With 2 vertical standards and longitudinal ledgers.

If the length has to be equalised across corners, one possible solution is with the aid of the rigid wedge head coupler (2628.xxx, see Fig. 133). Using the rigid wedge head coupler, the bay adjoining at right angles is connected to the O-longitudinal ledger. The gap between the longitudinal and the transverse sections also has to be closed. In the projecting bay, the side protection must be provided with the aid of tubes and couplers.

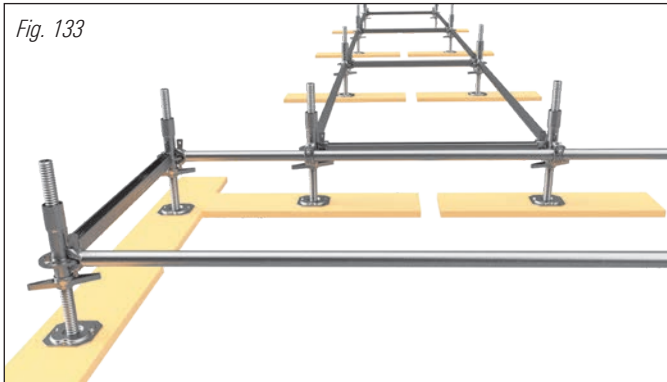

Bracket 0.73 m

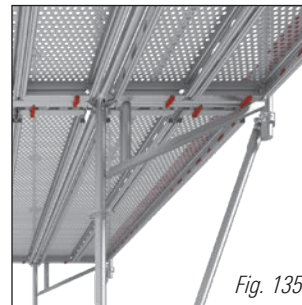

1. Fit bracket 0.73 m to the rosette.
2. Fit the bracket brace. Information on load-bearing capacity can be found in our Allround technical brochure.

Tip: Fitting a diagonal brace increases the load-bearing capacity of the bracket.

3. Lay the steel decks and close the lift-off preventer.

16. BRACKETS AND PROJECTIONS

Brackets should be fitted from the secured level underneath. Any additional anchoring must be installed at the same time. The gap between bracket deck and scaffolding deck in the main bay must be closed, for example using an O-ledger, gap ledger, gap cover or gap deck (see section 4) in accordance with local regulations.

Bracket 0.39 m

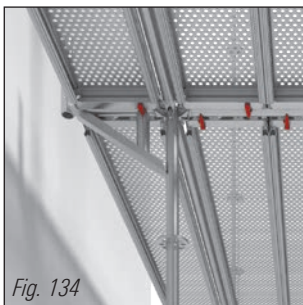

1. Fit bracket 0.39 m to the rosette.
2. Lay the steel deck and close the lift-off preventer.

Bracket 0.69 m, adjustable

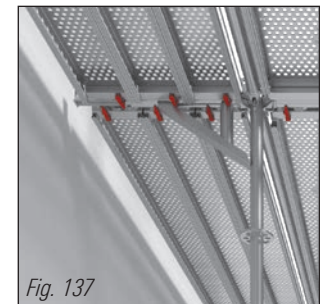
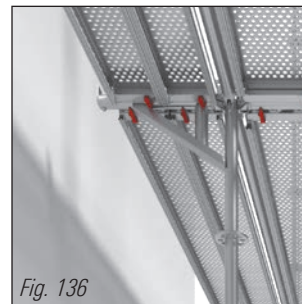

1. Fit bracket 0.69 m, adjustable, to the rosette.
2. In the pushed-in position, lay two steel decks, 0.19 m wide. In the pulled-out position, lay three steel decks, 0.19 m wide. The maximum loading of the bracket depends on the deck layout and deck length.

Bracket structure of standards, ledgers and diagonal braces

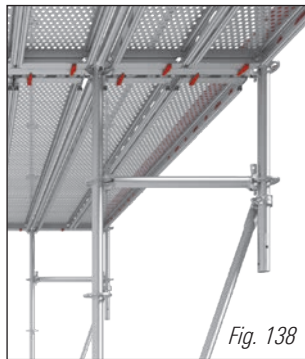

1. Fit both ledgers.
2. Connect the vertical standard.
3. Fit the vertical diagonal brace.
4. Lay the steel decks and close the lift-off preventer.

Tip: In this design variant, collision of the vertical diagonal braces with the decks is prevented. Depending on the load, it must be ensured that diagonal braces are fastened only to braced connectors. It may be necessary to fit an additional O-longitudinal ledger to the lower diagonal brace connection. The load-bearing capacity of the diagonal brace must be verified. Information on when a double diagonal brace has to be installed can be found in our Allround technical brochure.

Bracket, 1.09 m

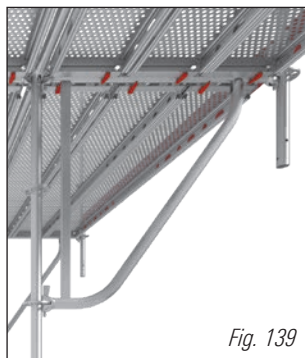

1. Fit bracket 1.09 m to the rosettes.
2. Lay the steel decks and close the lift-off preventer.
3. Connect outer vertical standard to the wedge head of the bracket 1.09 m. Depending on the load, further measures may have to be taken at the lower bracket end to transmit the loads.

Projections using cantilever method



1. Preassemble the bridging ledger / reinforced ledger, the base collar (or standard) and the diagonal brace, then tie them together with a rope or strap.
2. Connect the preassembled unit with the diagonal head to the upper rosette of the vertical standard.

NOTE

Diagonal braces should be fitted whenever possible to the outside. This supports the use of horizontal advance guardrails and makes assembly of the work level easier. The risk of inadvertent knocking out of the wedge is also reduced.



Fig. 141



3. Undo the securing rope / strap. Press the bridging ledger / reinforced ledger outwards and attach the wedge head to the rosette of the vertical standard.
4. Repeat the process on the opposite side.

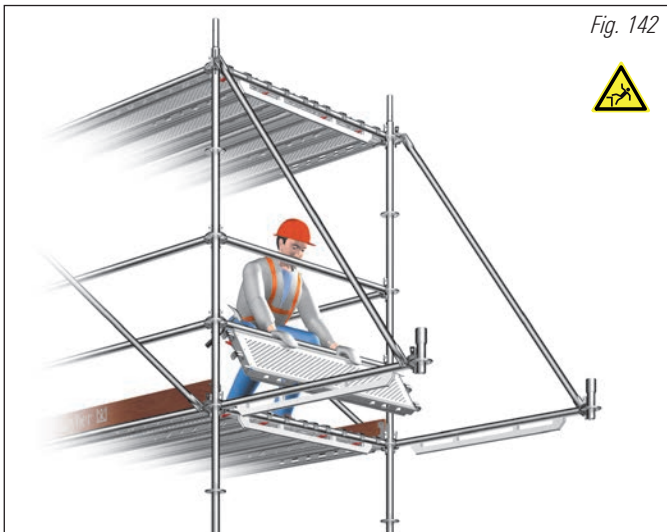

Fig. 142



5. When fitting the steel decks always remain behind the guardrails.
6. Slide steel decks over the transom to fill the bracket bay.

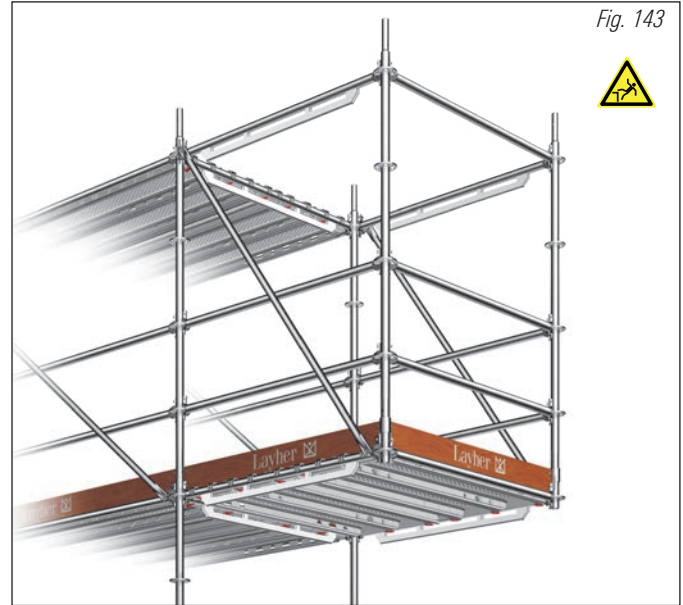

Fig. 143



7. Fit vertical standards onto the base collars. There is an increased risk of falls during this assembly step. We strongly recommend the use of PPE with attachment to already fitted rearward standards or ledgers.
8. Fit three-part side protection, comprising handrail, intermediate rail, lift-off preventer and toe board. Knock in the wedges.

Verify in each case that the scaffolding structure has sufficient load-bearing capacity. If necessary, the main scaffolding must be ballasted and constructed pull-resistant. Information on the load-bearing capacity of vertical diagonal braces can be found in the Allround approvals or in our Allround technical brochure. Fitting of multiple-bay projections is possible. Projections require sufficiently stable main scaffolding. Only fit and remove scaffolding decks from a secured position.

WARNING

Careless removal of wedges in load-bearing components can lead to a collapse of the scaffolding and the risk of serious injuries or fatalities. See also the warnings on page 50 in this respect.

17. BRIDGING WITH LATTICE BEAMS

Bridging of gateways, building projections, balconies or openings can be achieved using Allround lattice beams (Figs. 144 / 145) or lattice-like Allround structures (Fig. 146). Stronger bridging structures are possible with the Allround FW System or the Allround Bridging System.

When lattice beams are used, it must be ensured that the compression chords are sufficiently braced against sideways drift, e.g. using a tube/coupler brace or anchoring. The connections of the lattice beams to the support scaffolding, and also the support scaffolding itself, must be dimensioned sufficiently strong to transmit the support loads of the lattice beams safely into the ground. Information on load-bearing capacities can be found in our Allround technical brochure and in our Guideline for Professional Users.

Bridging variant with Allround lattice beams

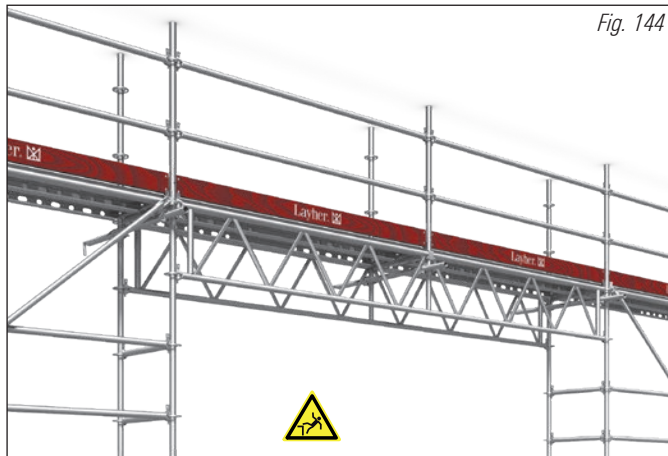

1. Connect the Allround lattice beam with 4 wedge head to the vertical standards from the secured level underneath.
2. Fit the spigot for the lattice beam at the centre of the latter, using temporary boards and assuring they have the correct span.
3. Attach the anchoring of the lattice beam centrally, if structurally necessary.
4. Fit the lattice beam ledger over the spigots of the lattice beams.

5. Insert the steel decks and close the lift-off preventer.
6. Fit vertical standards onto the spigots for lattice beams.
7. Fit three-part side protection, comprising handrail, intermediate rail and toe board.



Verify in each case that the bridging structure has sufficient load-bearing capacity.

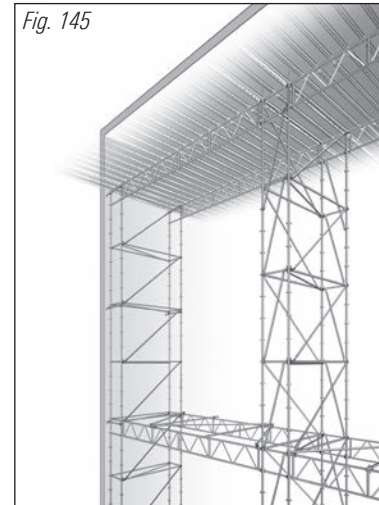

With Allround lattice beams, birdcage scaffolding can be constructed with less material.

Bridging variant with Allround basic components

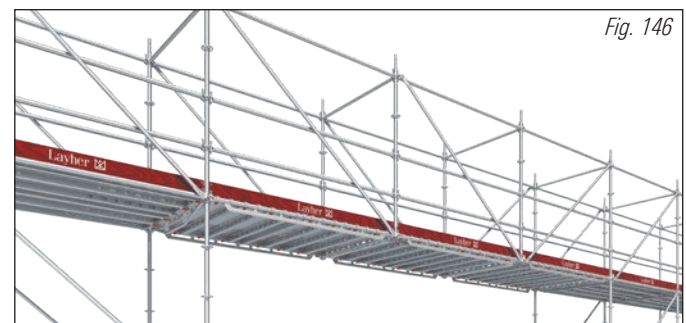

Bridging is also possible using an Allround FW System structure. See section 16 on Brackets and projections using cantilever method for the assembly sequence. Depending on the diagonal bracing alignment,

tensile forces can act in the posts, the transmission of which is not assured in a design with base collars. It is therefore recommended that the posts are constructed unjoined and without base collars. The load-bearing capacity of the vertical diagonal braces and ledgers must be verified. In addition to the tensile and compressive stress resistance of the chords, the connection too is frequently crucial. The ledgers of the FW System chords should be connected to the small holes of the rosettes.

18. BRICK GUARD

The geometrical dimensions of the brick guard, e.g. the width of the scaffolding or the distance from the eaves must be in accordance with local regulations. Scaffolding widening using brackets may be necessary.

Caution: At the top level, only decks suitable for use in roof brick guard and standard brick guards may be used. No access decks may be installed in the bracket area at the guard level. For details on this please refer to the Allround approvals.

The facade scaffolding must be constructed as described in section 5. At the top level, the standards of the 2.00 m high protective wall must be reinforced on the outside using 3.00 m long Allround standards connected on the outside using double wedge head couplers. The double wedge head couplers must be attached at the level of the topmost deck level, 1.00 m above it and 1.50 m below it. With a roof brick guard, every connector must be anchored at the top anchoring levels. If the Allround standards of the protective wall are designed abutting at the deck level, they must be secured using bolts or locking pins.

Protection net

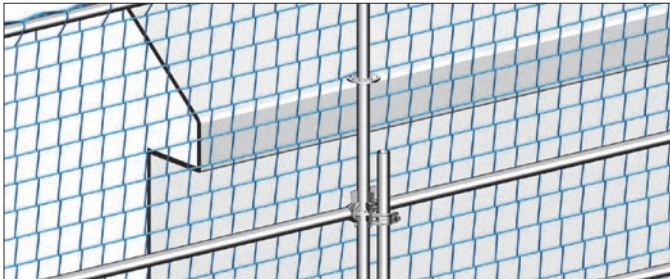

In the case of protective walls with protection nets, O-ledgers must be installed at distances of 0.50 m, 1.00 m and 2.00 m from the topmost deck level in addition to the O-ledgers at the deck level. The nets must be attached to horizontal ledgers at the bottom (at the working level) and at the top (2 m above the working level). Only nets designed for this purpose may be used.

1. To fit the protection net, ledgers are required on the outside at the top working level.
2. A toe board, an intermediate rail and a handrail are required in any event.

For protection nets without quick strap fasteners:

3. In the first step, fit the O-ledge.
4. Thread the net into the ledger at the deck level in every mesh. Connect ledger.
5. Thread the net into the top ledger in every mesh. Connect ledger.

For protection nets with quick strap fasteners:

6. The ledger at the deck level can be fitted from the secured level underneath it.
7. Fit further ledgers.
8. With quick strap fasteners, the protection net must be attached to the ledgers every 75 cm. All quick strap fasteners must be firmly closed.

Caution: Protection nets must be inspected. If older protection nets are used, it must be verified by inspections that the maximum tensile strength of the net yarn is still at least 2 kN.

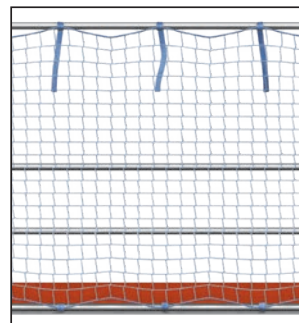

Fig. 149: Protection net with quick strap fastener

19. GROUND ADJUSTMENT

On uneven and sloping ground, it is recommended that scaffolding assembly starts at the highest point of the assembly surface.

Adjustment to minor ground irregularities and height differences in the ground is achieved using adjustable base plates.

Caution: The maximum loading of the base plate must not be exceeded when adjusting it, and if necessary the base plate must be stiffened with a tube connected to the base plate by a wedged swivel coupler.

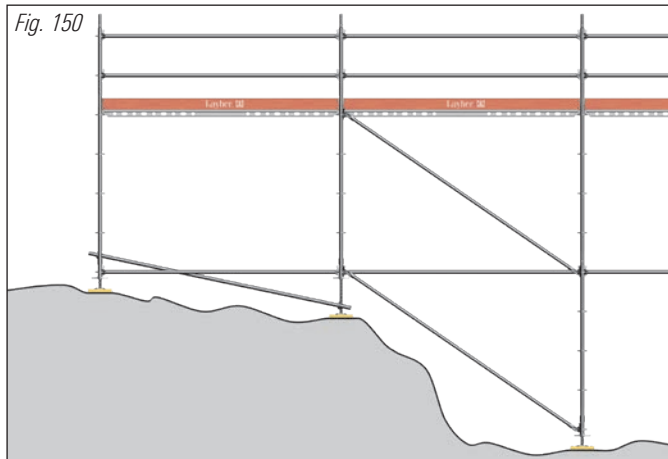

Major height differences can be balanced out by additional vertical standards. Additional standards must be braced with diagonal braces to the base point.

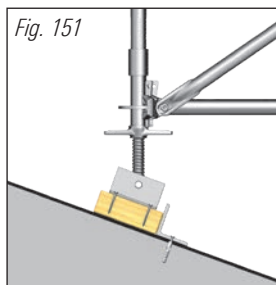

Adjustment to sloping surfaces is achieved by using swivelling base plates. **Caution:** Here in particular the load-distributing bases and the base plates must be secured against slipping, and sufficient structural strength of the swivelling base plates must be assured. The base plates must be in full-surface contact with the load-distributing supports.

20. CHANGE IN STANDARD CONFIGURATION

Allround Scaffolding can be optimally adjusted to local conditions.

Tapering of wide scaffolding in the transverse direction



1. Assemble scaffolding as described in section 5, using bridging ledgers / reinforced ledgers in the transverse direction.
2. Fit spigots with half-couplers in the intended configuration dimension on the upper chord of the bridging ledger/reinforced ledger. Tighten the half-coupler with a tightening torque of 50 Nm.

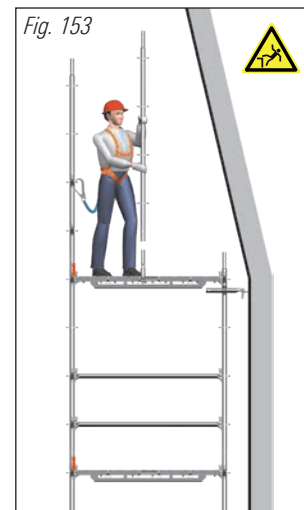

3. Insert decks and secure them against lifting off.
4. Assemble next level with a reduced width.

Caution: Check that the bridging ledgers/reinforced ledgers have sufficient load-bearing capacity. Details about this can be found in our Allround technical brochure. The three-part side protection of guardrail, intermediate rail and toe board must be installed at all work levels on the outside of the scaffolding.

This method can be applied analogously for reducing the bay width in the longitudinal direction and for birdcage scaffolding. A combination with ledgers in the lengths 0.25 m, 0.50 m or 1.00 m is recommended.

21. USE OF THE SCAFFOLDING

- After assembly of the scaffolding it must be checked and identified by the scaffolding erector in accordance with section 1 (inspection and documentation).
- The scaffolding may only be entered via its accesses; climbing up the scaffolding is prohibited.
- No heavy objects may be thrown onto scaffolding decks, which may only be subjected to the maximum loads listed for the specified load classes.
- Jumping onto scaffolding decks is prohibited.
- No ladders, boxes etc. may be used at the top scaffolding level to increase the working height.
- When material or components are stored at the work level, a free passage width of at least 20 cm must be assured.
- Only decks that are fully in place may be walked on.
- Keep hatches in access decks closed when not in use.
- Do not overload the scaffolding.
- Do not store materials on protective roofs and brackets.
- Do not endanger the scaffolding by excavation work in the foundation area.

Additionally applicable for rolling towers:

- The wheels of the rolling tower must be locked before it is used.
- No personnel or materials may be on the tower while it is being moved. Movement only by applying manual force to the base.
- The travel distance must be flat and free of obstacles.

22. DISMANTLING THE SCAFFOLDING

To dismantle scaffolding, the sequence of working steps described for assembly must be reversed. Stability must be assured in all assembly states. The following must be noted in addition:

- The scaffolding constructor must ensure that all reasonably predictable risks to health and safety from dismantling of the scaffolding are detected before and during dismantling.
- Safety measures, to be verified by the scaffolding constructor, must

be taken for any risks detected.

- Anchoring must not be released until the scaffolding levels above it have been completely dismantled.
- Remove immediately components of which the connectors have been released.
- Removed scaffolding components must not be thrown down from the scaffolding.
- Scaffolding components must be stored properly.
- Only levels that have been fully decked may be walked on.
- The scaffolding may only be entered using the accesses.
- Climbing up the scaffolding is prohibited.

WARNING

Inadvertent undoing of connections of load-bearing components (e.g. diagonal braces) reduces the stability of the scaffolding structure and can cause it to collapse.

If PPE is used, ensure that it is not attached to a scaffolding structure or scaffolding component intended for dismantling.

NOTE

If there are further wedges at the rosette of the wedge head connection to be undone, it is recommended to place a hand above those wedges which should not be knocked out.

This ensures that even when the wrong wedge is loosened the wedge head connection has a residual load-bearing capacity.



Fig. 154



Fig. 155



23. COMPONENTS

Vertical support elements of steel and aluminium

Standard, steel, with press-in spigot

Ref. No. 5603.050, 0.50 m
Ref. No. 2603.xxx, 1.00 – 4.00 m

Standard, steel, without spigot

Ref. No. 2604.xxx, 0.50 – 4.00 m

Standard, aluminium, with press-in spigot

Ref. No. 3200.xxx, 1.00 – 4.00 m

Standard, aluminium, without spigot

Ref. No. 3209.xxx, 1.00 – 4.00 m

Standard LW, steel with integrally cast spigot

Ref. No. 2617.xxx, 0.50 – 4.00 m

Standard LW, steel without spigot

Ref. No. 2619.xxx, 1.50 – 2.00 m

Spigot for 2604.xxx

Ref. No. 2605.000

Spigot for 3209.xxx

Ref. No. 3209.000

Lattice beam pin dia. 12 x 65 mm with safety clip, 2.8 mm

Ref. No. 4905.065/4905.000

Special bolt M12 x 60

with nut, Ref. No. 4905.060

Hinged pin dia. 12 mm,

Ref. No. 4905.666

Locking pin, red

Ref. No. 4000.001

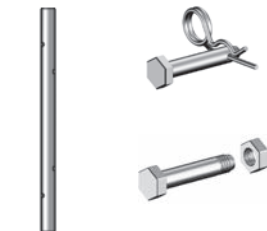

Base collar,

Ref. No. 2602.000

Base collar, extended,

Ref. No. 2660.000



Scaffolding spindles

Base plate 60,

Ref. No. 4001.060, 0.60 m

Base plate 80, reinforced,

Ref. No. 4002.080, 0.80 m

Swivelling base plate 60, reinforced

Ref. No. 4003.000, 0.60 m

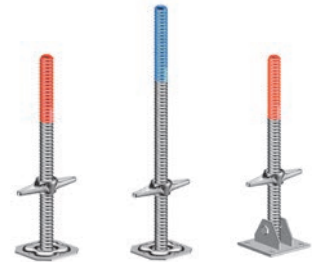

Head jack 60, solid,

Ref. No. 5314.060,
14 – 16 cm fork width

Swivelling head jack 45, solid,

Ref. No. 5312.045,
14 – 16 cm fork width

Cross head jack 45, solid

Ref. No. 5315.045



Head part for heavy-duty column,

Ref. No. 5312.003

Base part for heavy-duty column,

Ref. No. 5312.002



Head jack for heavy-duty column,

Ref. No. 5312.004

Base plate for heavy-duty column,

Ref. No. 5312.001



Horizontal support elements, side protection



O-ledge, steel, Ref. No. 2607.xxx, 0.25 – 4.14 m

O-ledge, aluminium, Ref. No. 3201.xxx, 0.73 – 3.07 m



O-ledge, steel, reinforced, Ref. No. 2611.xxx, 1.09 and 1.29 m



U-ledge, steel, Ref. No. 2613.xxx, 0.45, 0.50, 0.73, 1.09 (LW) and 1.40 m (LW)

U-ledge, aluminium, Ref. No. 3203.073, 0.73 m



U-ledge, aluminium, reinforced, Ref. No. 3203. xxx, 1.09 and 1.40 m



U-ledge, steel, reinforced, LW, Ref. No. 2613. xxx, 1.57 – 3.07 m



U-bridging ledger, steel, Ref. No. 2624. xxx, 1.57 – 3.07 m

U-bridging ledger, aluminium, Ref. No. 3207. xxx, 1.57 – 2.07 m



O-bridging ledger, steel, Ref. No. 2625. xxx, 1.57 – 3.07 m



O-ledge, steel, reinforced, LW Ref. No. 2672.xxx, 1.09 – 3.07 m



U-lift-off preventer

Ref. No. 2635.xxx, 0.39 – 1.57 m

Ref. No. 2658.xxx, 2.07 – 3.07 m



U-ledge (steel deck-steel deck)

Ref. No. 2614. xxx, 0.32, 0.65 and 0.97 m



O-ledge (steel deck-steel deck)

Ref. No. 2614. xxx, 0.32, 0.70 and 1.09 m



O-support ledger, Ref. No. 2615. xxx, 0.73 – 3.07 m



O-toe board, wood, Ref. No. 2642. xxx, 0.73 – 3.07 m

U-toe board, wood, Ref. No. 2640. xxx, 0.73 – 4.14 m

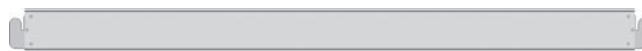

O-toe board, aluminium, Ref. No. 2641. xxx, 0.73 – 3.07 m

U-toe board, aluminium, Ref. No. 2651. xxx, 0.73 – 4.14 m



O-steel toe board, Ref. No. 2648. xxx, 0.73 – 3.07 m

U-steel toe board, Ref. No. 2649. xxx, 0.73 – 3.07 m

Diagonal bracing

Diagonal brace LW, steel for 2 m bay height, Ref. No. 2683.xxx, 0.73 – 4.14 m

Diagonal brace, steel for 0.50 m, 1.00 m and 1.50 m bay height, Ref. No. 2680.xxx, 2681.xxx, 2682.xxx, 1.57 – 3.07 m

Diagonal brace, aluminium, for 2 m bay height, Ref. No. 3204.xxx, 0.73 – 3.07 m



O-ledge, horizontal-diagonal, Ref. No. 2608.xxx, 1.57 x 1.57 m – 3.07 x 3.07 m
For rectangular layouts with wedge heads welded off-centre.
For square layouts with wedge heads welded in a straight line.

Scaffolding decks, access decks



U-steel deck, T4, 0.32 m wide, Ref. No. 3812.xxx, 0.73 – 4.14 m



O-steel deck, T9, 0.32 m wide, Ref. No. 3861.xxx, 0.73 – 4.14 m



U-steel deck, 0.19 m wide, Ref. No. 3801.xxx, 1.57 – 3.07 m

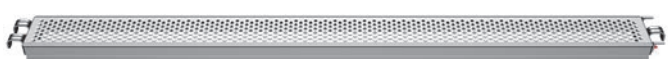

O-steel deck, 0.19 m wide, Ref. No. 3848.xxx, 0.73 – 3.07 m



Steel plank, perforated,
Ref. No. 3878.xxx, 0.20 m wide 1.00–2.50 m
Ref. No. 3880.xxx, 0.30 m wide 1.00 – 2.50 m
available with 1, 2 or no steel pins



Steel gap cover, perforated,
Ref. No. 3881.xxx, 0.32 m wide 0.73–3.07 m



Locking pin



Locking screw red



Locking screw blue

Ref. No. 3800.006 Ref. No. 3800.009 / 010 Ref. No. 3800.011 / 012



U-solid wood deck, 0.32 m wide, Ref. No. 3818.xxx, 1.57 – 3.07 m



U-Xtra-N deck, 0.61 m wide, Ref. No. 3866.xxx, 0.73 – 3.07 m



U-robust deck, 0.61 m wide, Ref. No. 3835.xxx, 0.73 – 3.07 m

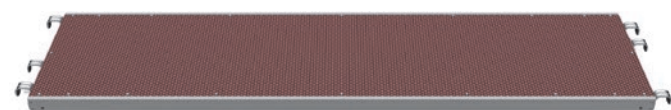

O-robust deck, 0.61 m wide, Ref. No. 3870.xxx, 0.73 – 3.07 m



U-robust deck, 0.32 m wide, Ref. No. 3836.xxx, 1.57 – 3.07 m



U-stalu deck, 0.61 m wide, Ref. No. 3850.xxx, 1.57 – 3.07 m



U-stalu deck, 0.32 m wide, Ref. No. 3856.xxx, 1.57 – 4.14 m



U-aluminium deck, 0.32 m wide, Ref. No. 3803.xxx, 1.57 – 3.07 m

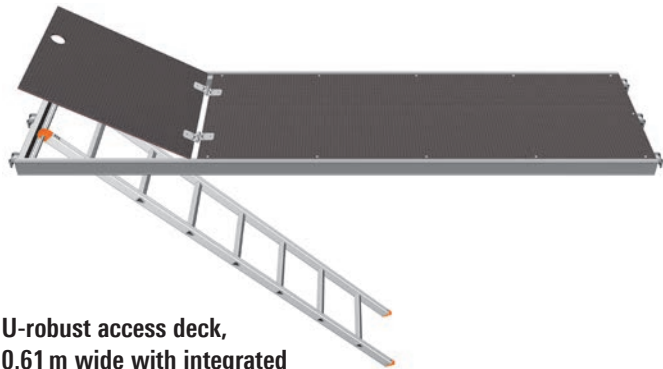

**U-robust access deck,
0.61 m wide with integrated
access ladder*, Ref. No. 3838.xxx, 2.57 – 3.07 m**

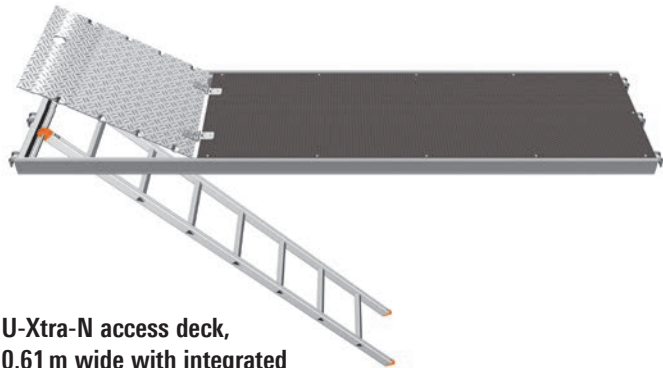

**U-Xtra-N access deck,
0.61 m wide with integrated
access ladder*, Ref. No. 3869.xxx, 2.57 – 3.07 m**

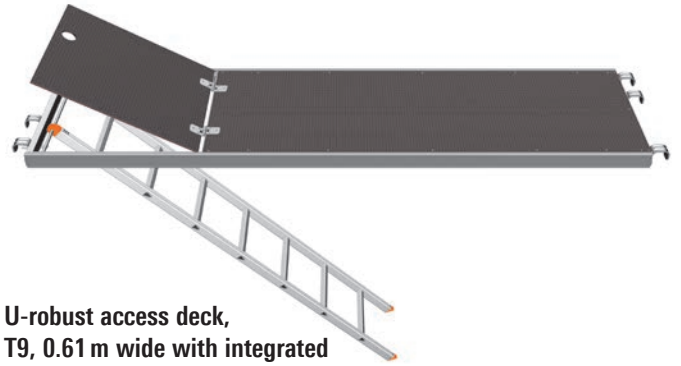

**U-robust access deck,
T9, 0.61 m wide with integrated
access ladder*, Ref. No. 3872.xxx, 2.57 – 3.07 m**

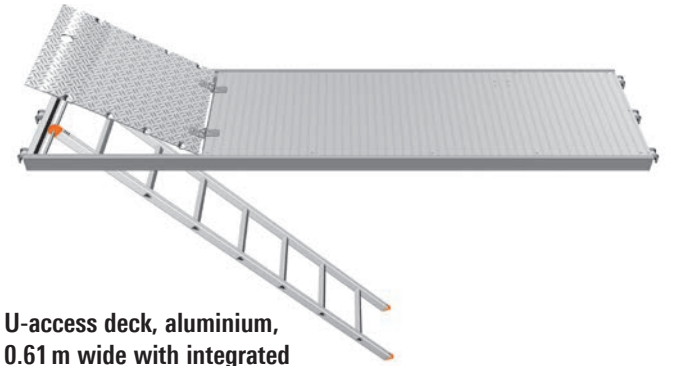

**U-access deck, aluminium,
0.61 m wide with integrated
access ladder*, Ref. No. 3852.xxx, 2.57 – 3.07 m**

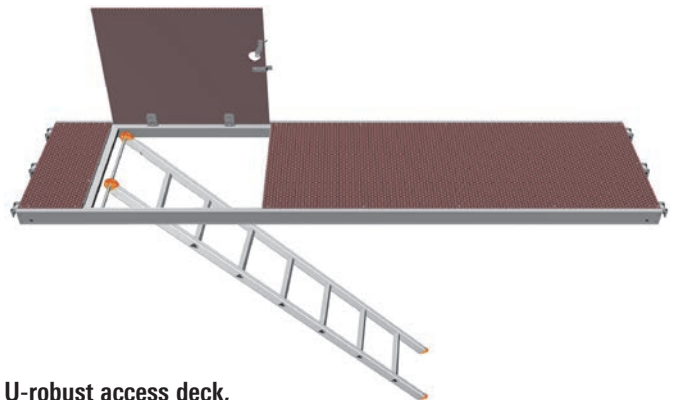

**U-robust access deck,
0.61 m wide with integrated access ladder*,
access hatch side-opening Ref. No. 3859.xxx, 2.57 – 3.07 m**

** Also available without integrated ladder*

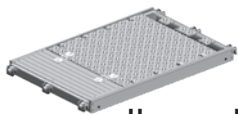

U-access deck, aluminium,
0.61 m wide, 1.00 m long
Ref. No. 3851.100 m

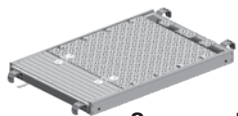

O-access deck, aluminium,
0.61 m wide, 1.00 m long
Ref. No. 3,871.100 m

Access ladder, 7-rung,
Ref. No. 4008.007, 2.15 m



Brackets

U-bracket, LW,
Ref. No. 2632.xxx,
0.28 m, 0.39 m and 0.73 m



O-bracket,
Ref. No. 2631.xxx,
0.26, 0.39 and 0.73 m



O-bracket, adjustable,
Ref. No. 2630.069,
0.69 m



Bracket brace, Ref. No. 2631.205, 2.05 m



U-bracket, 1.09 m wide,
Ref. No. 2630.109, 1.09 m



O-bracket, 1.09 m wide,
Ref. No. 2631.109, 1.09 m

Lattice beams



O-lattice beam with 4 wedge heads, Ref. No. 2659.xxx, 5.14 – 7.71 m



U-lattice beam with 4 wedge heads, steel,
Ref. No. 2656.xxx, 3.07 – 6.14 m

U-lattice beam with 4 wedge heads, aluminium,
Ref. No. 3206.xxx, 1.57 – 5.14 m

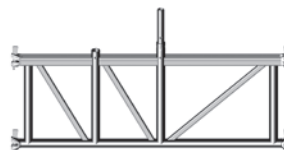

U-walkway beam, 1.57 m wide, Ref. No. 2665.157

U-ledger, for lattice beams,
Ref. No. 4923.xxx
0.73 and 1.09 m



Spigot for U-lattice beam,
Ref. No. 2656.001 / 002

Spigot for O-lattice beam,
Ref. No. 4706.xxx



Brick guard

Brick guard
Ref. No. 2663.xxx,
1.57 – 3.07 m



Platform stair



U-platform stair, aluminium,
Ref. No. 1753.xxx
2.57 m and 3.07 m



U-comfort stair, aluminium,
Ref. No. 1755.xxx
2.57 m and 3.07 m

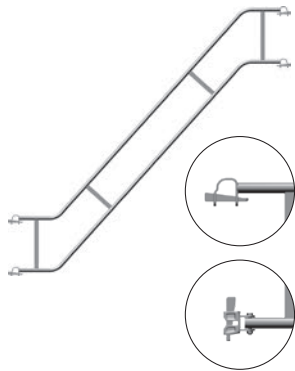

Stair guardrail 2.00 m high,
with U-prongs or swivelling
wedge heads;
Ref. No. 2638.xxx, 2.57 – 3,07 m



Stair guardrail adapter,
Ref. No. 2637.000



**Inner stair guardrail T12
2.00 m high,**
Ref. No. 1752.007/008,
for 2.57 m and 3.07 m stairs



Continuous stair guardrail,
Ref. No. 1752.004/014

Outside access, stairtower

**Access ladder,
aluminium,** Ref. No. 1004.xxx,
2.90 m, 4.00 m, 4.90 m and 5.70 m

**Access ladder,
steel,** Ref. No. 1002.xxx,
1.50 m, 2.00 m, 3.00 m and 4.00 m

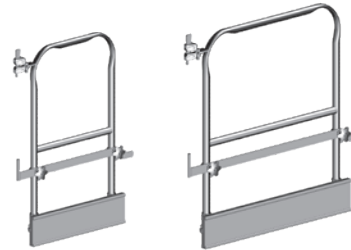

**Swing door with aluminium
toe board,** Ref. No. 2627.xxx,
0.73 and 1.00 m

Spring clip, 11 mm pin,
Ref. No. 1250.000



Guardrail standard, 1.70 m, offset,
Ref. No. 2606.170





U-stairway stringer 200, 10 steps, 2.00 m storey height,
Ref. No. 2638.010, 2.00 x 2.57 m

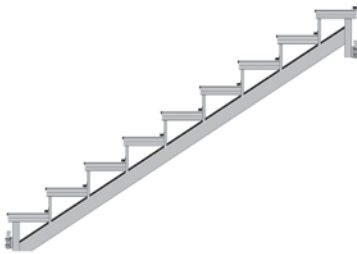

U-stairway stringer 500, 9 steps, Ref. No. 2638.009, 2.00 x 2.57 m

U-stairway stringer 500, 5 steps, Ref. No. 2638.004, 1.00 x 1.57 m

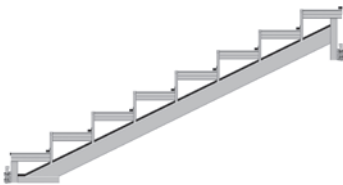

U-stairway stringer 750, 8 steps, Ref. No. 2638.008, 1.50 x 2.57 m

U-stairway stringer 750, 5 steps, Ref. No. 2638.005, 1.00 x 1.57 m

**Stair guardrail 500,
9 steps,**
Ref. No. 2616.100,
2.00 x 2.57 m

**Stair guardrail 500,
5 steps,**
Ref. No. 2616.104,
1.00 x 1.57 m

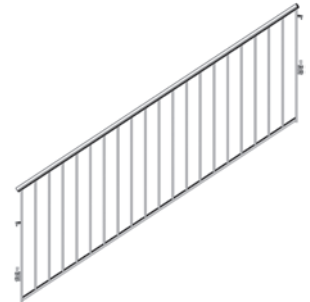

**Stair guardrail 750,
8 steps,** Ref. No. 2616.101,
1.50 x 2.57 m

**Stair guardrail 750,
5 steps,** Ref. No. 2616.105,
1.00 x 1.57 m

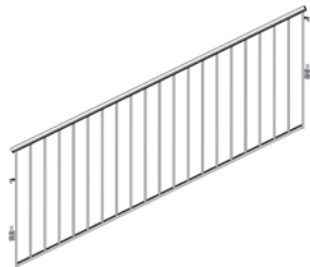

**Guardrail with child safety fea-
ture,** Ref. No. 2616.xxx,
0.73 – 2.57 m



U-gap ledger,
Ref. No. 2675.xxx,

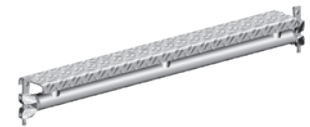

U-gap deck with wedge heads,
Ref. No. 2602.xxx
0.73 – 3.07 m

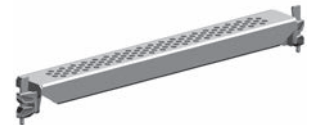

U-gap cover with claw,
Ref. No. 3868.xxx,
1.09 – 2.07 m



Advance guardrail

Advance guardrail post,
for one advance guardrail
(1 m height), aluminium,
Ref. No. 4031.001

Advance guardrail post,
for two advance guardrails
(0.50 and 1 m height), aluminium,
Ref. No. 4031.002



Advance guardrail,
aluminium,
Ref. No. 4031.207,
1.57 – 2.07 m
Ref. No. 4031.307,
2.57 – 3.07 m



End AGR,
Advance guard
rail for end face of
scaffolding,
Ref. No. 4031.000



Anchoring

Allround wall tie,
Ref. No. 2639.080,
0.80 m



Couplers



Wedge head coupler, rigid,
Ref. No. 2628.xxx



Wedge head coupler, swivelling,
Ref. No. 2629.xxx



Wedge head coupler LW, double
Ref. No. 2629.000

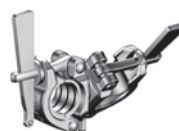

Wedge spindle swivel coupler
Ref. No. 4735.000



Rosette, clampable,
Ref. No. 2602.019/022



Rosette, clampable, with thread,
Ref. No. 2602.119/122



Layher® 

More Possibilities. The Scaffolding System.

Wilhelm Layher GmbH & Co KG
Scaffolding Grandstands ladders

Ochsenbacher Strasse 56
74363 Gueglingen-Eibensbach
Germany

Post box 40
74361 Gueglingen-Eibensbach
Germany
Phone +49 (0)71 35 70-0
Fax +49 (0)71 35 70-2 65
E-Mail info@layher.com
www.layher.com

